

Your Solution Partner In
Industrial Valve Automation...



Rubber Lined Wafer Type **BUTTERFLY VALVE**



Mfg. & Mkt by :

aira Euroautomation pvt. ltd.
INDIA



www.airaindia.com



About Us

Clients are why we exist!

We welcome and thank you for referring out detailed catalogue.

aira is know all over continents as a manufacturer of quality products - Ball Valves, Butterfly Valves, Plug Valves, & Control On / Off Valves with Pneumatic Actuators for Pharma, Oil & Gas, Steel, Paper, Water, Chemical and all type of processing industries.

aira has walked through more than 3 decades, gaining valuable experience, offering equipment's in the products manufactured by OEMs in all spheres of engineering. **aira** products have gained reputations of consultants, and approvals of users, OEMs and other as a quality product.

aira has expanding business into foreign markets specially GCC, UAE, Asian & African countries. This is because increase its customer base and revenue, leading to overall growth and success. Now foreign users come to know and believe in the services provided by the **aira**. Along with the same, it also helps to reach a large number of users thereby leading to the increase their business.

Being and ISO 9001 BVQI certified company has put **aira** in fore front. Out motto is "Value the customer" and "Superior product", one among the best in the world.

Our Quality

- In- House full scale testing facility.
- Lean manufacturing practices
- Certified by : ISO 9001 : 2015 (BVQI LONDON), CE, ATEX, CIMFR, BIS, PESO, SIL 3, IBR
- API 609, API 6D

Our Commitment

- To understand customer's need first before proposing our products.
- To keep on providing competitive rate's by adapting to continuous process improvement, without compromising on quality.
- To provide continuous support to our customers and go beyond their expectations in terms of delivery and after sale services.

Our Manufacturing Facility

- In house R & D, manufacturing and testing facility is all located in a spread over three campuses at Ahmedabad, Gujarat, INDIA.

Network - Sales Office

- 60 Plus Branch Offices in different states in India.
- Sales office in the Bangladesh, Dubai, Kenya, Malaysia, Nepal, Qatar, Singapore, South Africa, Sri Lanka, Turkey, USA (Expanding).

www.airaindia.com



QMS (Quality Management System)

ISO 9001 : 2015

EMS (Environment Management System)

ISO 14001 : 2015

OHSAS (Occupational Health & Safety Management System)

ISO 45001 : 2018

IBR
PISTON VALVE
GLOBE CONTROL VALVE (CKD/CND)
DISC CHECK VALVE (DCV)
PRESSURE REDUCING VALVE (PRV)
POP TYPE SAFETY VALVE
BALL VALVE

Pneumatic Actuator

CE /
ATEX /
EXIDA SIL-3 /
PROOF OF DESIGN

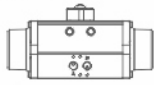

Scotch & Yoke Actuator

CE / ATEX / SIL-3

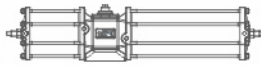

Stainless Steel Actuator

CE /
IEP ATEX



Positioner Enclosure

CE / CIMFR /
IP67 / BIS
/ PESO

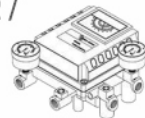

aira's
SOME OF OUR
Certificates

Plug Valve

FUGITIVE EMISSIONS
TEST
AS PER ISO
15848-1 / IBR

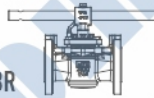

Flameproof Solenoid Valve

IEP ATEX / CE / CIMFR
/ IP65 / IP67 / IP68 /
BIS / PESO

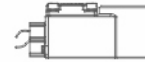

Limit Switch

IEP ATEX / CE / CIMFR
/ IP67 / BIS / PESO /
EQDC IP68



Ball Valve (Floating & Trunnion)

FIRE SAFE TEST DESIGN /
FUGITIVE EMISSIONS TEST
AS PER ISO 15848-1 / CE /
PED /
EXIDA SIL-3

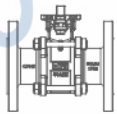

Butterfly Valve (centric / Double & Triple Eccentric)

FIRE SAFE TEST DESIGN /
FUGITIVE EMISSIONS TEST
AS PER ISO 15848-1 / CE /
PED / EXIDA SIL-3
/ IBR / PROOF OF DESIGN /
FOOD GRADE / BIS / ISI



Multiport Ball Valve

FUGITIVE EMISSIONS TEST
AS PER ISO 15848-1 / CE /
PED / EIL

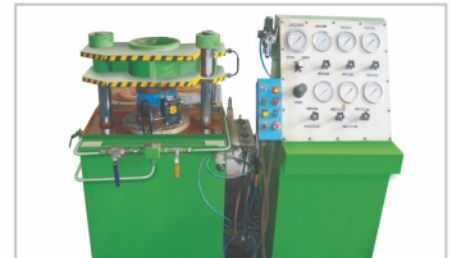
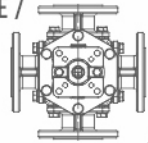

Company Profile

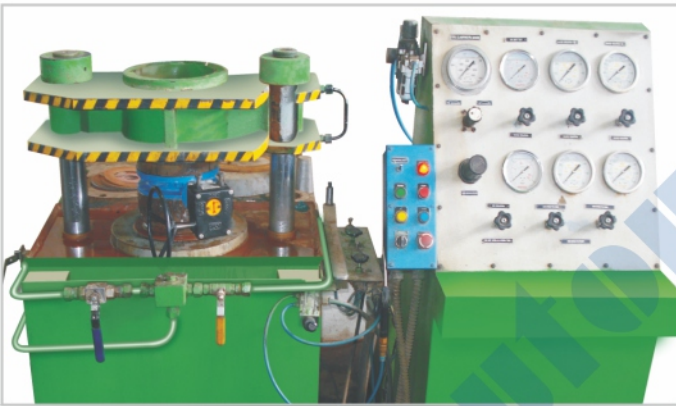

www.airaindia.com



Rubber Lined Wafer Type Butterfly Valve



"aira" Offers Resilient-seated, butterfly valve for flange mounting to pipelines; concentric disc design; with replaceable liner. Suitable for use in cooling towers, waste-water applications, water treatment, water distribution, dams, gas main and service lines, pressure stations, gas storage tanks, power plants and gas pipelines industry.

Size Range : 1.1/2" to 48" (40 MM to 1200 MM)

Butterfly Valve Specification	
Valve Type	Centric Disc Butterfly Valve with Single Piece Rubber Lined Body
Body Type	Short Wafer Type
Seat Type	Integrally Molded with The Body (Renewable Seat On Request) Upto 24"
End Connection	Wafer Type Suit 150#, Table 'D', Table 'E' & IS 6392 Table 11 (PN 10 / PN 16)
Pressure Rating	PN 10 / PN 16
Oper. Temp. Range	-20 °C to 80 °C For Nitrile Seat (Depending On MOC)
Seat Leakage	Tight Shut Off

Accessories

- On / OFF Indicator
- NAMUR Standard Solenoid Valve in all Standard Coil Voltage (Flame Proof Solenoid Coil - On Request)
- Pneumatic & Electro-Pneumatic valve positioner
- Decutchable Manual Over - Ride
- Limit Switches for On / Off Indication at Panel Board
- Filter + Regulator Combination with Pressure Gauge
- Air Lock Valve



Item	Type Of Test	Testing Pressure	Temperature	
			Normal	High
Actuator	Pneumatic Bubble Test	8 Kg/cm ²	-20 °C to 80 °C	High Temp. On Request
Valve Body	Hydraulic	15 Kg/cm ²	Max. 80 °C	High Temp. On Request
Seat	Hydraulic	10 Kg/cm ²	Max. 80 °C	High Temp. On Request

Standard

- Design And Manufacturer : API 609 category A / IS : 13095 / BS EN 593
- Valve Face To Face Dimension : Short Wafer As Per ISO 5752 TAB 5 / API 609 Category A ISO 5752 TAB 1 / BS EN - 593 / BS EN - 558
- Flange Standard Conformity : ASME B16.5 / 16.47 Series A Class 150,
- Inspection & Testing : API 598 / BS EN 12266 - 1
- Top Flange Drilling : ISO 5211

Equipped in - house State - of - art rubber lining machine for butterfly valve upto 72".

Size Range : Upto 1.1/2" to 3" (40 MM to 80 MM)

Sr. No.	Description	Material
1	Body	ASTM - A 126 Grade B (Gray Iron)
		ASTM - A 216 Grade WCB (Cast Steel)
		ASTM - A 536 Grade 65-45-12 (Ductile Iron)
		ASTM - A 351 Grade CF8 / CF8M / CF3M / CD4MCuN
		ASTM - A 126 Grade B (Gray Iron) + Powder Coated
2	Disc	ASTM - A 216 Grade WCB (Cast Steel) + Powder Coated
		ASTM - A 536 Grade 65-45-12 (Ductile Iron) + Powder Coated
		ASTM - A 351 Grade CF8 / CF8M / CF3M / CD4MCuN
		S.G.Iron with PTFE / Powder / Nylon Coated & Rubber Line
		Nitrile / EPDM / Viton / Hypelon / Neopren
3	Seat	Nitrile / EPDM / Viton / Hypelon / Neopren
4	Shaft	AISI 410 / AISI 304 / AISI 316 / AISI 316L
5	Bearing Bush	Metal Bush PTFE Coated
6	Bush	Delrin
7	'O' Ring	Nitrile / EPDM / Viton / Hypelon / Neopren
8	Actuator	STD.

Dimensions :

Valve Model	Size		Port ±5MM	C ±2MM	ØD** ±5MM	Weight Approx. Kgs.
	Inch	MM				
ECO - IC - 40	1.1/2"	40	40	34	80	3
ECO - IC - 50	2"	50	50	44	95	3.25
ECO - IC - 65	2.1/2"	65	65	46	108	5
ECO - IC - 80	3"	80	80	46	124	5.25

(All Dimensions are in mm)

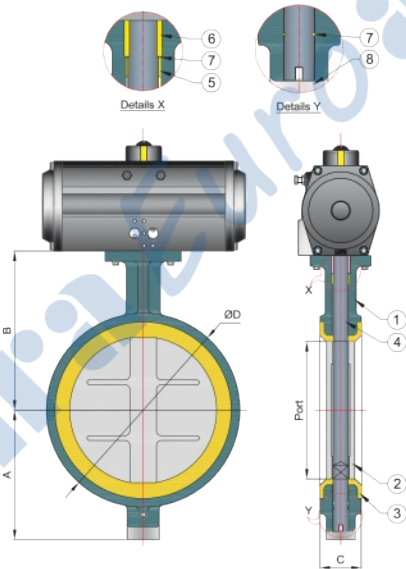

www.airaindia.com

Rubber Lined Wafer Type Butterfly Valve

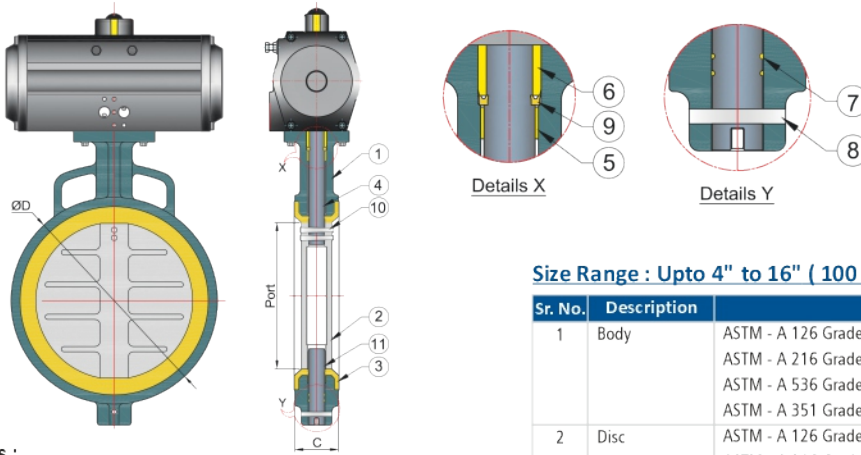

Dimensions :

Valve Model	Size		Port ±5MM	C ±2MM	ØD** ±5MM	Weight Approx.
	Inch	MM				
ECO - IC - 100	4"	100	100	52	150	6.5
ECO - IC - 125	5"	125	125	56	186	10.6
ECO - IC - 150	6"	150	150	56	205	11.5
ECO - IC - 200	8"	200	200	60	258.5	20
ECO - IC - 250	10"	250	241	68	321	24.900
ECO - IC - 300	12"	300	286	78	368	33.500
ECO - 350	14"	350	333	78	438	43
ECO - 400	16"	400	382	102	490	63

(All Dimensions are in mm)

Size Range : Upto 4" to 16" (100 MM to 400 MM)

Sr. No.	Description	Material
1	Body	ASTM - A 126 Grade B (Gray Iron) ASTM - A 216 Grade WCB (Cast Steel) ASTM - A 536 Grade 65-45-12 (Ductile Iron) ASTM - A 351 Grade CF8 / CF8M / CF3M / CD4MCuN
2	Disc	ASTM - A 126 Grade B (Gray Iron) + Powder Coated ASTM - A 216 Grade WCB (Cast Steel) + Powder Coated ASTM - A 536 Grade 65-45-12 (Ductile Iron) + Powder Coated ASTM - A 351 Grade CF8 / CF8M / CF3M / CD4MCuN
3	Seat	Nitrile / EPDM / Viton / Hypelom / Neopren
4	Shaft	AISI 410 / AISI 304 / AISI 316 / AISI 316L
5	Bearing Bush	Metal Bush PTFE Coated
6	Bush	PTFE
7	'O' Ring	Nitrile / EPDM / Viton / Hypelom / Neopren
8	Dowel Pin	M.S. / AISI 304 / AISI 316 / AISI 316L
9	'V' Seal	Nitrile / EPDM / Viton / Hypelom / Neopren
10	Taper Pin	AISI 304 / AISI 316 / AISI 316L
11	Bottom Pin	AISI 410 / AISI 304 / AISI 316 / AISI 316L

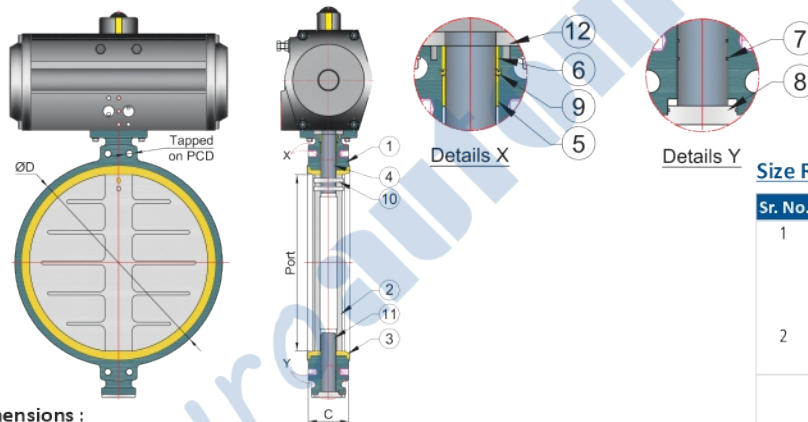

Dimensions :

Valve Model	Size		Port ±5MM	C ±2MM	ØD** ±5MM	PCD	Tapped ±5MM	Weight Approx.
	Inch	MM						
ECO - 450	18"	450	433	114	602	577.9	1" UNC	94
ECO - 500	20"	500	476	127	700	635	1" UNC	124.30
ECO - 600	24"	600	590	154	695	749.3	1.1/4" UNC	241.5
ECO - 650	26"	650	635	165	740	806.4	1.1/4" UNC	215
ECO - 700	28"	700	680	165	799	863.6	1.1/4" UNC	278.150
ECO - 750	30"	750	725	190	857	914.4	1.1/4" UNC	338.300
ECO - 800	32"	800	785	190	912	977.9	1.1/2" UNC	387.100
ECO - 850	34"	850	810	190	970	1028.7	1.1/2" UNC	----
ECO - 900	36"	900	885	203	1025	1085.8	1.1/2" UNC	484.8
ECO - 950	38"	950	935	216	1090	1149.4	1.1/2" UNC	----
ECO - 1000	40"	1000	965	216	1131	1200.2	1.1/2" UNC	----
ECO - 1100	44"	1100	1085	254	1245	1314.45	1.1/2" UNC	----
ECO - 1200	48"	1200	1170	254	1350	1422.4	1.1/2" UNC	----

(All Dimensions are in mm)

Size Range : Upto 18" to 48" (450 MM to 1200 MM)

Sr. No.	Description	Material
1	Body	ASTM - A 126 Grade B (Gray Iron) ASTM - A 216 Grade WCB (Cast Steel) ASTM - A 536 Grade 65-45-12 (Ductile Iron)
2	Disc	ASTM - A 351 Grade CF8 / CF8M / CF3M / CD4MCuN ASTM - A 126 Grade B (Gray Iron) + Powder Coated ASTM - A 216 Grade WCB (Cast Steel) + Powder Coated ASTM - A 536 Grade 65-45-12 (Ductile Iron) + Powder Coated ASTM - A 351 Grade CF8 / CF8M / CF3M / CD4MCuN
3	Seat	Nitrile / EPDM / Viton / Hypelom / Neopren
4	Shaft	AISI 410 / AISI 304 / AISI 316 / AISI 316L
5	Bearing Bush	Metal Bush PTFE Coated
6	Bush	PTFE
7	'O' Ring	Nitrile / EPDM / Viton / Hypelom / Neopren
8	Bottom Plate	IS 2062 Gr. B
9	'V' Seal	Nitrile / EPDM / Viton / Hypelom / Neopren
10	Taper Pin	AISI 304 / AISI 316 / AISI 316L
11	Bottom Pin	AISI 410 / AISI 304 / AISI 316 / AISI 316L
12	Gland Plate	IS 2062 Gr. B

Model : APP-1200-L
APP-1200-R

"aira" Rotary / Liner Type Pneumatic - Pneumatic Valve Positioner



Input Signal : 3 ~ 15psi (0.2-1.0 kgf/cm²)
Supply Air Pressure : 100 psi Max. (7.0 kgf/cm²)
Standard Stroke : 10 ~ 80mm
Air Piping Connection : 1/4" NPT (F)
Temperature : -20 °C to 70 °C
Pressure Gauge : Stainless Steel
Explosion-Proof : Ex 'd' II CT6
Degree of Protection : IP66
Pressure Gauge : Stainless Steel 0-2 kg/cm²
0-4 kg/cm² / 0-10 kg/cm²
: Rotary

Output Characteristics
Linearity : Within ± 1.0% F.S.
Sensitivity : Within 0.2% F.S.
Hysteresis : Within 0.2% F.S.
Repeatability : Within ± 0.75% F.S.
Air Consumption : 5.0 LPM (1.4 kg/cm²) Supply
Flow Capacity : 80 LPM (1.4 kg/cm²) Supply
Material : Aluminium Die cast Body
Weight : 1.8 Kg. (Approx)

IS / IEC 60079-1
CML-3812155
CIMFR
CE
CCEO Nagpur

Model : AEP-1000-L
AEP-1000-R

"aira" Rotary / Liner Flameproof cum Waeatherproof Electro Pneumatic Valve Positioner



Input Signal : 4~20 mA DC
Input Resistance : 235 ±15
Supply Air Pressure : 20 ~ 100psi (7.0 kg/cm²)
Standard Stroke : 10 ~ 80mm
Air Piping Connection : 1/4" NPT (F)
Conduit Connection : 1/2" NPT (F)
Explosion-proof : Ex 'd' II CT6
Degree of Protection : IP66
Temperature : -20 °C to 70 °C
Pressure Gauge : Stainless Steel 0-2 kg/cm²
0-4 kg/cm² / 0-10 kg/cm²
: Rotary

Output Characteristics
Linearity : Within ± 1.0% F.S.
Sensitivity : Within 0.2% F.S.
Hysteresis : Within 0.75% F.S.
Repeatability : Within ± 0.5% F.S.
Air Consumption : 5.0 LPM (1.4 kg/cm²) Supply
Flow Capacity : 80 LPM (1.4 kg/cm²) Supply
Material : Alluminium Die Cast Body
Weight : 2.8 Kg. With a terminal box

IS / IEC 60079-1
CML-3812155
CIMFR
CE
CCEO Nagpur

"aira" Weatherproof Micro Limit Switch Box Dom Indicator Type On/Off Indicator



Type : Mechanical Switch X 2 / Proximity Sensors P&F Make
Model Switch : LA4 - FLP - 01
: Honywell V15 / Honywell V15 / NJ2-V3-N (Upto 8V) / NBB3-V3-Z4 (Upto 10 to 60 VDC)
Type Switch Rating : 1 NO + 1 NC / 2 NO + 2 NC
: AC 250V 3A, 125V 5A & DC 250V 0.2A, 125V 0.4A, 30V 4A
Enclosure Protection : IP 67
Temperature : -20 °C ~ 80 °C
Conduit Entry : NPT 1/2" (PT 1/2", PF 1/2, M20, PG 13.5)
Terminal Mounting Bracket : 8 Points
: Namur VDI / VDE 3845, ISO 5211
Material : Aluminum Pressure Die Cast

CIMFR
CE
CCEO Nagpur

"aira" Flameproof Limit Switch Box



Type : Mechanical Switch X 2 / Proximity Sensors P&F Make
Model Switch : MLS - BX - FLP - 01
: Honywell V15 / Honywell V15 PCB Type / NJ2-V3-N (Upto 8V) / NBB3-V3-Z4 (Upto 10 to 60 VDC)
Type Switch Rating : 1 NO + 1 NC / 2 NO + 2 NC
: AC 250V 3A, 125V 5A & DC 250V 0.2A, 125V 0.4A, 30V 4A
Enclosure Protection : IP 67
Temperature : -20 °C ~ 80 °C
Conduit Entry : NPT 1/2" (PT 1/2", PF 1/2, M20, PG 13.5)
Terminal Mounting Bracket : 8 Points
: Namur VDI / VDE 3845, ISO 5211
Material : Aluminum Pressure Die Cast

IS / IEC 60079-1
CML-3812155
CIMFR
CE
CCEO Nagpur

"aira" Flameproof Micro Limit Switch Box with Stainless Steel 304 / 316



Type : Mechanical Switch X 2 / Proximity Sensors P&F Make
Model Switch : LS4 - FLP-01
: Honywell V15 / Honywell V15 PCB Type / NJ2-V3-N (Upto 8V) / NBB3-V3-Z4 (Upto 10 to 60 VDC)
Type Switch Rating : 1 NO + 1 NC / 2 NO + 2 NC
: AC 250V 3A, 125V 5A & DC 250V 0.2A, 125V 0.4A, 30V 4A
Enclosure Protection : IP 67
Temperature : -20 °C ~ 80 °C
Conduit Entry : NPT 1/2" (PT 1/2", PF 1/2, M20, PG 13.5)
Terminal Mounting Bracket : 8 Points
: Namur VDI / VDE 3845, ISO 5211
Material : Stainless Steel 304 / 316

CIMFR
CE
CCEO Nagpur

"aira" Weatherproof Limit Switch Box



Type : Mechanical Switch X 2 / Proximity Sensors P&F Make
Model Switch : MMLS - BX - WP - 01
: Honywell ZM / NJ2 - V3 - N (Upto 8 Voltage) / NBB - V3 - Z4 (Upto 10 to 60 VDC)
Type Switch Rating : 1 NO + 1 NC
: AC 250V 3A, 125V 5A & DC 250V 0.2A, 125V 0.4A, 30V 4A
Enclosure Protection : IP 67
Temperature : -20 °C ~ 80 °C
Conduit Entry : NPT 1/2" (PT 1/2", PF 1/2, M20, PG 13.5)
Terminal Mounting Bracket : 8 Points
: Namur VDI / VDE 3845, ISO 5211
Material : Aluminum Pressure Die Cast

CIMFR
CE
CCEO Nagpur

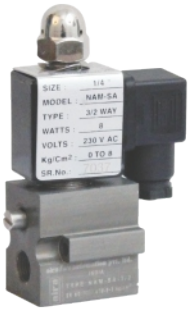

“aira” 3/2 Way Namur Direct Acting Solenoid Valve

Model	: NAM-SA-32
Coil Voltage	: All Std. Voltage Available
Frequency	: 50 - 60 Hz
Connection Type	: 1/4" (BSP / NPT)
Conduit	: PF 1/2"
Coil Insulation Grade	: Class "F"
Temperature	: -20 °C ~ 70 °C (-4 ~ 158 °F)
MOC	: Aluminium
Seals	: NBR (Viton On Request)
Working Pressure	: Upto 8 BAR

This 3/2 Namur is suitable for actuator model : 5412-S / ARA-49S / ARA-50S



“aira” 3/2 & 5/2 Way Convertible Poppet Type Single Namur Solenoid Valve

Model	: OTX - PPT - 32 / OTX - PPT - 52
Coil Voltage	: All Std. Voltage Available
Frequency	: 50 - 60 Hz
Connection Type	: 1/4" (BSP / NPT)
Conduit	: PF 1/2"
Coil Insulation Grade	: Class "F"
Temperature	: -20 °C ~ 70 °C (-4 ~ 158 °F)
MOC	: Aluminium
Seals	: NBR (Viton On Request)
Working Pressure	: Upto 8 BAR



“aira” 3/2 & 5/2 Way Convertible Poppet Type Double Namur Solenoid Valve

Model	: 2OTX - PPT - 52
Coil Voltage	: All Std. Voltage Available
Frequency	: 50 - 60 Hz
Connection Type	: 1/4" (BSP / NPT)
Conduit	: PF 1/2"
Coil Insulation Grade	: Class "F"
Temperature	: -20 °C ~ 70 °C (-4 ~ 158 °F)
MOC	: Aluminium
Seals	: NBR (Viton On Request)
Working Pressure	: Upto 8 BAR



“aira” 3/2 & 5/2 Way Convertible Spool Type Single Namur Solenoid Valve

Model	: AMV-NAM-220
Coil Voltage	: All Std. Voltage Available
Frequency	: 50 - 60 Hz
Connection Type	: 1/4" (BSP / NPT)
Conduit	: PF 1/2"
Coil Insulation Grade	: Class "F"
Temperature	: -20 °C ~ 70 °C (-4 ~ 158 °F)
Body Material	: Aluminium
Seals	: NBR (Viton On Request)
Working Pressure	: Upto 8 BAR



“aira” 3/2 & 5/2 Way Convertible Spool Type Double Namur Solenoid Valve

Model	: 2AMV-NAM-220
Coil Voltage	: All Std. Voltage Available
Frequency	: 50 - 60 Hz
Connection Type	: 1/4" (BSP / NPT)
Conduit	: PF 1/2"
Coil Insulation Grade	: Class "F"
Temperature	: -20 °C ~ 70 °C (-4 ~ 158 °F)
Body Material	: Aluminium
Seals	: NBR (Viton On Request)
Working Pressure	: Upto 8 BAR



“aira” AJ Series 3/2 Way Direct Acting Solenoid Valve (Normally Open & Closed)

Model	: AIDS-09-202
Size	: 1/4" BSP
Body	: Aluminium Pressure Die Cast
Orifice	: 2 MM
Pressure	: 7 Kg/cm ² / 10 Kg/cm ²
Temp.	: Upto 50 °C
Leakage	: Bubble Tight
Frequency	: 50 ~ 60 Hz
Coil Insulation Grade	: Class "F"
Media	: Air (Filtered & Lubricated)
Voltage	: All Std. Voltage Available



“aira” Filter + Regulator Air Combination

Model	: 4FQ / 8 FQ / FRJ
Air Connection	: 1/4" BSP
Max. Supply Pressure	: 4FQ: 0.5 to 4 Kg/cm ² 8FQ: 0.5 to 8 Kg/cm ² 1 to 9 Kg/cm ²
Gauge Connection	: 1/8"
Ambient Temperature	: -20 °C ~ 120 °C (High Temp.) -40 °C ~ 120 °C (low Temp.)
Mini Filtering Size	: 5 Micron
Material	: Aluminium Pressure Die Cast

(4FQ / 8FQ) (FRJ)



“aira” Air Volume Booster

Model	: VLB
Size	: 1/4" to 1" BSP
MOC	: Aluminium / S. S. 304 / 316
Seals	: NBR
Max. Supply Pressure	: Max. 1Mpa (10 Bar)
Max. Output Pressure	: Max. 0.7 Mpa (7 Bar)
Temperature	: -20 °C ~ 70 °C (Standard) -20 °C ~ 120 °C (High) -40 °C ~ 70 °C (Low)
Linearity	: 1 : 1
Hysteresis	: 1%



“aira” Single & Double Air Lock Valve

Model	: SALV / DALV
Material	: Aluminum / Stainless Steel 304
Max. Supply Pressure	: Max. 10.2 Kg/cm ² (142 PSI)
Max. Single Pressure	: Max. 7.1 Kg/cm ² (1000 PSI)
Setting Pressure Range	: 1.4-7.1 Kg/cm ² (20 ~ 100 PSI)
Flow Capacity (Cv)	: 0.9
In/Output Port Connection	: 1/4" NPT
Signal Port Connection	: 1/4" NPT
Differential Pressure	: Below 0.1 Kg/cm ² (1.4 PSI)
Hysteresis	: 1%
ambient Temp.	: -20 °C ~ 70 °C

DALV SALV



“aira” Manual Override Clutch Type (MO)

Model	: AMO
Torque	: 200 Nm to 10000 Nm
Body	: Aluminium Pressure Die Cast / S. G. Iron
Lever Wheel	: Stainless Steel
Hand Wheel	: S. S. / M. S. (Fabricated)

Installations

- Indian Oil
- Reliance Industries Limited
- ONGC
- Hindalco
- Godrej
- Indian Railway
- Vedanta
- Voltas
- NTPC
- Gujarat State Fertilizers & Chemical Ltd.
- L & T
- Gail
- Hindustan Petroleum
- BHEL
- IFFCO
- BARC
- Thermax
- Essar

Application

- Process & Chemical
- Refineries & Petrochemicals
- Drugs & Pharmaceuticals
- Thermal Power Stations
- Dyes & Intermediates
- Breweries & Distilleries
- Steel Plants
- Onshore & Offshore Platforms
- Steel Plants
- Solvent Extraction Plants
- Sewage
- Cooling Water
- Ship Yards & Marine Management
- LPG Bottling Plants
- Water Works
- Pulp & Paper
- Fertilizers
- Textiles
- Sugar
- Nuclear & Atomic Power Stations
- Paints & Varnishes
- Soaps & Detergents
- Slurry & Ash handling
- Food & Oil Industry
- Effluent & Water Treatment

This Product is Generally made to use on the High Pressure Piping System, It is Widely Applied for Major Industrial Sectors

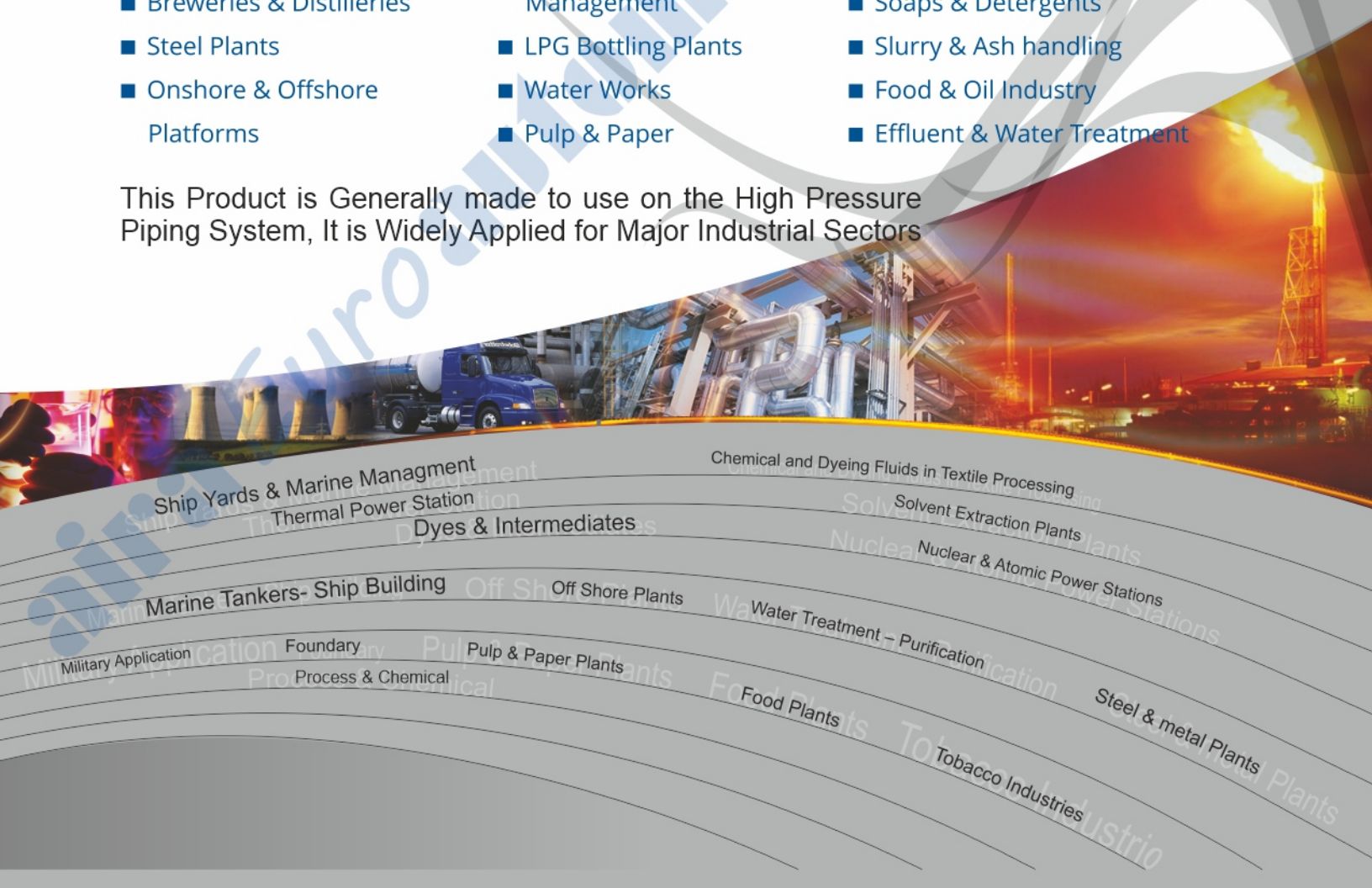

Ship Yards & Marine Management
Thermal Power Station

Dyes & Intermediates

Marine Tankers- Ship Building

Off Shore Plants

Military Application

Foundary

Pulp & Paper Plants

Water Treatment - Purification

Food Plants

Tobacco Industries

Steel & metal Plants

Chemical and Dyeing Fluids in Textile Processing

Solvent Extraction Plants

Nuclear & Atomic Power Stations



time tested designs with superior performance

GLOBAL

Network

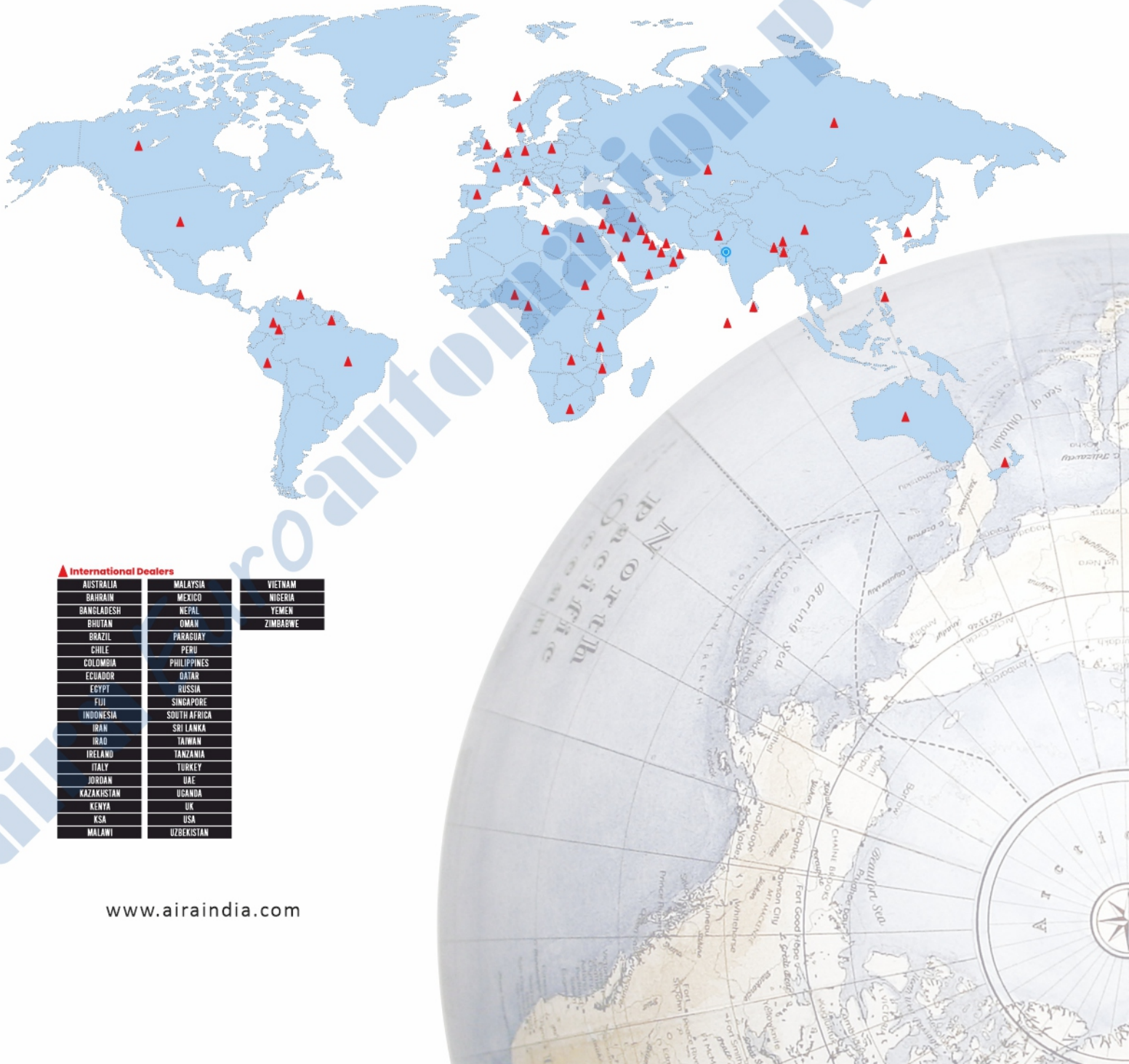

▲ International Dealers

AUSTRALIA	MALAYSIA	VIETNAM
BAHRAIN	MEXICO	NIGERIA
BANGLADESH	NEPAL	YEMEN
BHUTAN	OMAN	ZIMBABWE
BRAZIL	PARAGUAY	
CHILE	PERU	
COLOMBIA	PHILIPPINES	
ECUADOR	QATAR	
EGYPT	RUSSIA	
FUJI	SINGAPORE	
INDONESIA	SOUTH AFRICA	
IRAN	SRI LANKA	
IRAQ	TAIWAN	
IRELAND	TANZANIA	
ITALY	TURKEY	
JORDAN	UAE	
KAZAKHISTAN	UGANDA	
KENYA	UK	
KSA	USA	
MALAWI	UZBEKISTAN	



industrial valve automation

Network

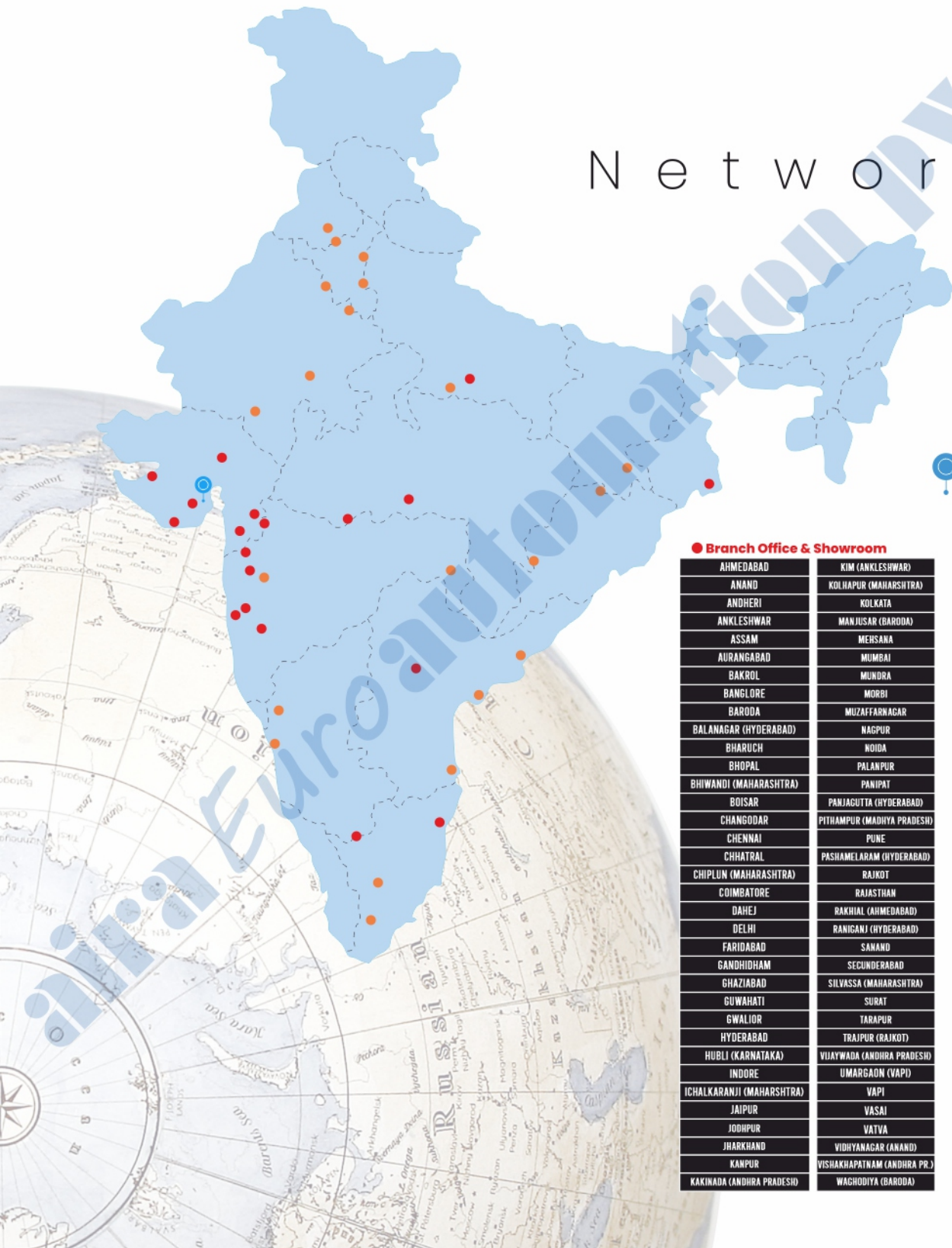

● Head Office & Works
AHMEDABAD

● Branch Office & Showroom

AHMEDABAD	KIM (ANKLESHWAR)
ANAND	KOLHAPUR (MAHARASHTRA)
ANDHERI	KOLKATA
ANKLESHWAR	MANJUSAR (BARODA)
ASSAM	MEHSANA
AURANGABAD	MUMBAI
BAKROL	MUNDRA
BANGLORE	MORBI
BARODA	MUZAFFARNAGAR
BALANAGAR (HYDERABAD)	NAGPUR
BHARUCH	NOIDA
BHOPAL	PALANPUR
BHIWANDI (MAHARASHTRA)	PANIPAT
BOISAR	PANJAGUTA (HYDERABAD)
CHANGODAR	PITHAMPUR (MADHYA PRADESH)
CHENNAI	PUNE
CHHATRAL	PASHAMELARAM (HYDERABAD)
CHIPLUN (MAHARASHTRA)	RAJKOT
COIMBATORE	RAJASTHAN
DAHEJ	RAKHIAL (AHMEDABAD)
DELHI	RANIGANJ (HYDERABAD)
FARIDABAD	SANAND
GANDHIDHAM	SECUNDERABAD
GHAZIABAD	SILVASSA (MAHARASHTRA)
GUWAHATI	SURAT
GWALIOR	TARAPUR
HYDERABAD	TRAJIPUR (RAJKOT)
HUBLI (KARNATAKA)	VIJAYWADA (ANDHRA PRADESH)
INDORE	UMARGAON (VAPI)
ICHALKARANJI (MAHARASHTRA)	VAPI
JAIPUR	VASAI
JODHPUR	VATVA
JHARKHAND	VIDHYANAGAR (ANAND)
KANPUR	VISHAKHAPATNAM (ANDHRA PR.)
KAKINADA (ANDHRA PRADESH)	WAGHODIYA (BARODA)

● Dealers & Distributors

AMRITSAR	KOLKATA
BALOTA	LUCKNOW
BANGLORE	LUDHIANA
BELGAUM	MARWAR
BHILWARA	MEERUT
CHANDICARH	MUZAFFARNAGAR
CHENNAI	NAGPUR
COCHIN	NOIDA
COIMBATORE	PANIPAT
DELHI	PEENYA
ERODE	PUNE
FARIDABAD	TRIPUR
GHAZIABAD	VARANASI
GOA	VISAKHAPATNAM
INDORE	WADI
JALANDHAR	KANPUR
JAMSHEDPUR	KOLHAPUR
JHARKHAND	

Mfg. & Mkt by :

aira Euroautomation pvt. ltd.
INDIA

Available At :