

Your Solution Partner In
Industrial Valve Automation...



Double Eccentric Off-Set Disc Wafer Type **BUTTERFLY VALVE**



Mfg. & Mkt by :

aira Euroautomation pvt. ltd.
INDIA





About Us

Clients are why we exist!

We welcome and thank you for referring out detailed catalogue.

aira is know all over continents as a manufacturer of quality products - Ball Valves, Butterfly Valves, Plug Valves, & Control On / Off Valves with Pneumatic Actuators for Pharma, Oil & Gas, Steel, Paper, Water, Chemical and all type of processing industries.

aira has walked through more than 3 decades, gaining valuable experience, offering equipment's in the products manufactured by OEMs in all spheres of engineering. **aira** products have gained reputations of consultants, and approvals of users, OEMs and other as a quality product.

aira has expanding business into foreign markets specially GCC, UAE, Asian & African countries. This is because increase its customer base and revenue, leading to overall growth and success. Now foreign users come to know and believe in the services provided by the **aira**. Along with the same, it also helps to reach a large number of users thereby leading to the increase their business.

Being and ISO 9001 BVQI certified company has put **aira** in fore front. Out motto is "Value the customer" and "Superior product", one among the best in the world.

Our Quality

- In- House full scale testing facility.
- Lean manufacturing practices
- Certified by : ISO 9001 : 2015 (BVQI LONDON), CE, ATEX, CIMFR, BIS, PESO, SIL 3, IBR
- API 609, API 6D

Our Commitment

- To understand customer's need first before proposing our products.
- To keep on providing competitive rate's by adapting to continuous process improvement, without compromising on quality.
- To provide continuous support to our customers and go beyond their expectations in terms of delivery and after sale services.

Our Manufacturing Facility

- In house R & D, manufacturing and testing facility is all located in a spread over three campuses at Ahmedabad, Gujarat, INDIA.

Network - Sales Office

- 60 Plus Branch Offices in different states in India.
- Sales office in the Bangladesh, Dubai, Kenya, Malaysia, Nepal, Qatar, Singapore, South Africa, Sri Lanka, Turkey, USA (Expanding).

www.airaindia.com



QMS (Quality Management System)

ISO 9001 : 2015

EMS (Environment Management System)

ISO 14001 : 2015

OHSAS (Occupational Health & Safety Management System)

ISO 45001 : 2018

IBR
PISTON VALVE
GLOBE CONTROL VALVE (CKD/CND)
DISC CHECK VALVE (DCV)
PRESSURE REDUCING VALVE (PRV)
POP TYPE SAFETY VALVE
BALL VALVE

Pneumatic Actuator

CE /
ATEX /
EXIDA SIL-3 /
PROOF OF DESIGN

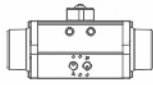

Scotch & Yoke Actuator

CE / ATEX / SIL-3

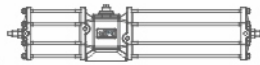

Stainless Steel Actuator

CE /
IEP ATEX



Positioner Enclosure

CE / CIMFR /
IP67 / BIS
/ PESO

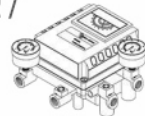

aira's
SOME OF OUR
Certificates

Plug Valve

FUGITIVE EMISSIONS
TEST
AS PER ISO
15848-1 / IBR

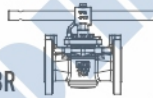

Flameproof Solenoid Valve

IEP ATEX / CE / CIMFR
/ IP65 / IP67 / IP68 /
BIS / PESO

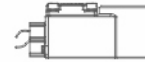

Limit Switch

IEP ATEX / CE / CIMFR
/ IP67 / BIS / PESO /
EQDC IP68



Ball Valve (Floating & Trunnion)

FIRE SAFE TEST DESIGN /
FUGITIVE EMISSIONS TEST
AS PER ISO 15848-1 / CE /
PED /
EXIDA SIL-3

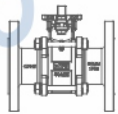

Butterfly Valve (centric / Double & Triple Eccentric)

FIRE SAFE TEST DESIGN /
FUGITIVE EMISSIONS TEST
AS PER ISO 15848-1 / CE /
PED / EXIDA SIL-3
/ IBR / PROOF OF DESIGN /
FOOD GRADE / BIS / ISI



Multiport Ball Valve

FUGITIVE EMISSIONS TEST
AS PER ISO 15848-1 / CE /
PED / EIL

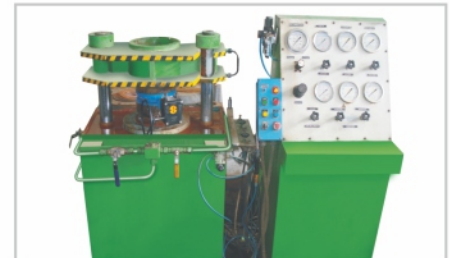
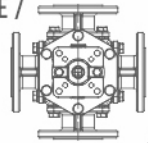

Company Profile

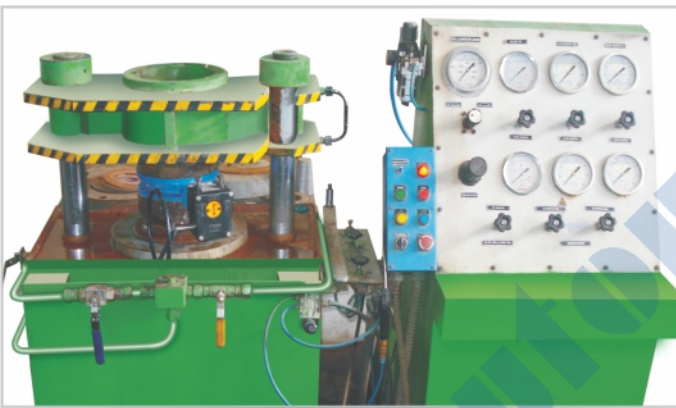

www.airaindia.com



Double Eccentric Off-Set Disc Wafer Type Butterfly Valve



"aira" Offers Double-offset wafer type butterfly valve (resilient-seated), available with long or short face-to-face length for use in most common flow control applications. Long service life, as the media does not come into contact with the bearing, and due to the wear-resistant, corrosion and infiltration-proof seat with weld overlay. Suitable for use water distribution, water treatment, pre-treated waste water, dams, power plants, industry and pressure management.

Size Range : 2.1/2" to 48" (65 MM to 1200 MM)

Pressure / Temperature Rating

Pressure Rating	150# / PN 10 / PN 16 / PN 25 / PN 40
Operating Temperature	NBR -10 °C to +90 °C
	EPDM -20 °C to +120 °C
	VITON -0 °C to +220 °C
	PTFE -25 °C to +180 °C

Fire Safe Design Available On Request

Accessories

- On / OFF Indicator
- NAMUR Standard Solenoid Valve in all Standard Coil Voltage (Flame Proof Solenoid Coil - On Request)
- Pneumatic & Electro-Pneumatic valve positioner
- Dec clutchable Manual Over - Ride
- Limit Switches for On / Off Indication at Panel Board
- Filter + Regulator Combination with Pressure Gauge
- Air Lock Valve

Standard

- Design And Manufacturer : API 609 Category "B" / MSS SP - 68 BS EN - 593
- Valve Face To Face Dimension : API 609 Category "B" / ISO 5752 MSS SP-68 / BS EN - 558
- Flange Standard Conformity : ASME / ANSI B 16.5 Class 150 ASME / ANSI B 16.47 Series "A & B" Class 150 / DIN 1092 - 1
- Inspection & Testing : API 598 / BS EN 12266 - 1
- Pressure Temperature Rating : ASME B 16.34
- Top Flange Drilling : Bolt Hole ISO 5211
- Steam Dimensions : Square Drive to ISO 5211
- Leakage Class : Class VI as per ANSI B 16, 16.104 / FCI - 70 - 2, ISO - 5208

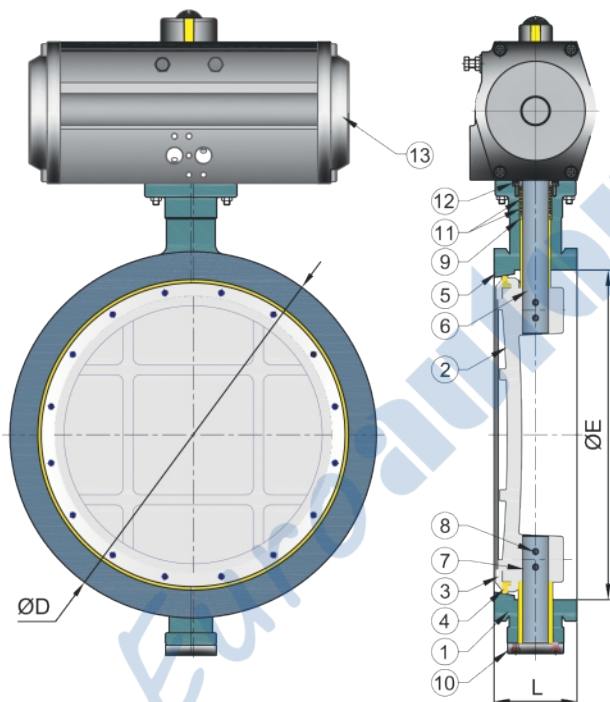

Sr. No.	Description	Material
1	Body	C.I. / WCB / CF8 / CF8M / D.I.
2	Disc	C.I. / WCB / CF8 / CF8M / D.I.
3	Retainer	M.S. / CF8 / CF8M
4	Disc Seal Ring	NBR / EPDM / Viton
5	Body Seat Ring	S.S. 304 / 316
6	Shaft	S.S. 304 / 316 / 410
7	Stem Shaft	S.S. 304 / 316 / 410
8	Disc Pin	S.S. 304 / 316 / 410
9	Flange Side Washer	S.S. 304 / 316 / 410
10	Stem Square	M.S. / CF8 / CF8M
11	Gland Seal Set	PTFE / NBR / EDPM / Viton
12	Gland Plate	M.S. / CF8 / CF8M

Dimensions :

Valve Model	Valve Size		L	ØD	ØE	Weight (Approx.)	
	MM	Inch				Sand Casting	IC Casting
BOD-65	65	2.1/2"	48	104.8	70	----	3
BOD-80	80	3"	48	127	86	----	3.8
BOD-100	100	4"	54	158	110	----	7
BOD-125	125	5"	56	185.87	120	----	9
BOD-150	150	6"	57	216	152	----	11
BOD-200	200	8"	64	270	200	----	17.5
BOD-250	250	10"	72	325	250	----	28
BOD-300	300	12"	81	373	306	----	37
BOD-350	350	14"	92	412	355	62	----
BOD-400	400	16"	102	472	400	97	----
BOD-450	450	18"	114	532	450	135	----
BOD-500	500	20"	127	584	505	170	----
BOD-600	600	24"	154	692.2	612	250	----
BOD-650	650	26"	165	749.3	640	315	----
BOD-700	700	28"	165	800.1	705	365	----
BOD-750	750	30"	190	857.25	725	490	----
BOD-800	800	32"	190	915	810	560	----
BOD-850	850	34"	205	965.2	850	635	----
BOD-900	900	36"	203	1022.35	900	700	----
BOD-1000	1000	40"	300	1124	1010	1070	----
BOD-1200	1200	48"	350	1359	1210	1920	----

[All Dimensions are in mm]

www.airaindia.com



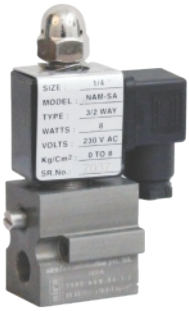

“aira” 3/2 Way Namur Direct Acting Solenoid Valve

Model	: NAM-SA-32
Coil Voltage	: All Std. Voltage Available
Frequency	: 50 - 60 Hz
Connection Type	: 1/4" (BSP / NPT)
Conduit	: PF 1/2"
Coil Insulation Grade	: Class "F"
Temperature	: -20 °C ~ 70 °C (-4 ~ 158 °F)
MOC	: Aluminium
Seals	: NBR (Viton On Request)
Working Pressure	: Upto 8 BAR

This 3/2 Namur is suitable for actuator model : 5412-S / ARA-49S / ARA-50S



“aira” 3/2 & 5/2 Way Convertible Poppet Type Single Namur Solenoid Valve

Model	: OTX - PPT - 32 / OTX - PPT - 52
Coil Voltage	: All Std. Voltage Available
Frequency	: 50 - 60 Hz
Connection Type	: 1/4" (BSP / NPT)
Conduit	: PF 1/2"
Coil Insulation Grade	: Class "F"
Temperature	: -20 °C ~ 70 °C (-4 ~ 158 °F)
MOC	: Aluminium
Seals	: NBR (Viton On Request)
Working Pressure	: Upto 8 BAR

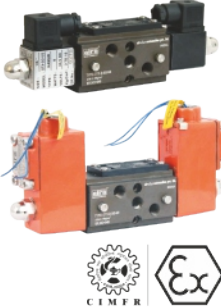

“aira” 3/2 & 5/2 Way Convertible Poppet Type Double Namur Solenoid Valve

Model	: 2OTX - PPT - 52
Coil Voltage	: All Std. Voltage Available
Frequency	: 50 - 60 Hz
Connection Type	: 1/4" (BSP / NPT)
Conduit	: PF 1/2"
Coil Insulation Grade	: Class "F"
Temperature	: -20 °C ~ 70 °C (-4 ~ 158 °F)
MOC	: Aluminium
Seals	: NBR (Viton On Request)
Working Pressure	: Upto 8 BAR



“aira” 3/2 & 5/2 Way Convertible Spool Type Single Namur Solenoid Valve

Model	: AMV-NAM-220
Coil Voltage	: All Std. Voltage Available
Frequency	: 50 - 60 Hz
Connection Type	: 1/4" (BSP / NPT)
Conduit	: PF 1/2"
Coil Insulation Grade	: Class "F"
Temperature	: -20 °C ~ 70 °C (-4 ~ 158 °F)
Body Material	: Aluminium
Seals	: NBR (Viton On Request)
Working Pressure	: Upto 8 BAR



“aira” 3/2 & 5/2 Way Convertible Spool Type Double Namur Solenoid Valve

Model	: 2AMV-NAM-220
Coil Voltage	: All Std. Voltage Available
Frequency	: 50 - 60 Hz
Connection Type	: 1/4" (BSP / NPT)
Conduit	: PF 1/2"
Coil Insulation Grade	: Class "F"
Temperature	: -20 °C ~ 70 °C (-4 ~ 158 °F)
Body Material	: Aluminium
Seals	: NBR (Viton On Request)
Working Pressure	: Upto 8 BAR



“aira” AJ Series 3/2 Way Direct Acting Solenoid Valve (Normally Open & Closed)

Model	: AIDS-09-202
Size	: 1/4" BSP
Body	: Aluminium Pressure Die Cast
Orifice	: 2 MM
Pressure	: 7 Kg/cm ² / 10 Kg/cm ²
Temp.	: Upto 50 °C
Leakage	: Bubble Tight
Frequency	: 50 ~ 60 Hz
Coil Insulation Grade	: Class "F"
Media	: Air (Filtered & Lubricated)
Voltage	: All Std. Voltage Available



“aira” Filter + Regulator Air Combination

Model	: 4FQ / 8 FQ / FRJ
Air Connection	: 1/4" BSP
Max. Supply Pressure	: 4FQ: 0.5 to 4 Kg/cm ² 8FQ: 0.5 to 8 Kg/cm ² 1 to 9 Kg/cm ²
Gauge Connection	: 1/8"
Ambient Temperature	: -20 °C ~ 120 °C (High Temp.) -40 °C ~ 120 °C (low Temp.)
Mini Filtering Size	: 5 Micron
Material	: Aluminium Pressure Die Cast

(4FQ / 8FQ) (FRJ)



“aira” Air Volume Booster

Model	: VLB
Size	: 1/4" to 1" BSP
MOC	: Aluminium / S. S. 304 / 316
Seals	: NBR
Max. Supply Pressure	: Max. 1Mpa (10 Bar)
Max. Output Pressure	: Max. 0.7 Mpa (7 Bar)
Temperature	: -20 °C ~ 70 °C (Standard) -20 °C ~ 120 °C (High) -40 °C ~ 70 °C (Low)
Linearity	: 1 : 1
Hysteresis	: 1%



“aira” Single & Double Air Lock Valve

Model	: SALV / DALV
Material	: Aluminum / Stainless Steel 304
Max. Supply Pressure	: Max. 10.2 Kg/cm ² (142 PSI)
Max. Single Pressure	: Max. 7.1 Kg/cm ² (1000 PSI)
Setting Pressure Range	: 1.4-7.1 Kg/cm ² (20 ~ 100 PSI)
Flow Capacity (Cv)	: 0.9
In/Output Port Connection	: 1/4" NPT
Signal Port Connection	: 1/4" NPT
Differential Pressure	: Below 0.1 Kg/cm ² (1.4 PSI)
Hysteresis	: 1%
ambient Temp.	: -20 °C ~ 70 °C

DALV SALV



“aira” Manual Override Clutch Type (MO)

Model	: AMO
Torque	: 200 Nm to 10000 Nm
Body	: Aluminium Pressure Die Cast / S. G. Iron
Lever Wheel	: Stainless Steel
Hand Wheel	: S. S. / M. S. (Fabricated)

Installations

- Indian Oil
- Reliance Industries Limited
- ONGC
- Hindalco
- Godrej
- Indian Railway
- Vedanta
- Voltas
- NTPC
- Gujarat State Fertilizers & Chemical Ltd.
- L & T
- Gail
- Hindustan Petroleum
- BHEL
- IFFCO
- BARC
- Thermax
- Essar

Application

- Process & Chemical
- Refineries & Petrochemicals
- Drugs & Pharmaceuticals
- Thermal Power Stations
- Dyes & Intermediates
- Breweries & Distilleries
- Steel Plants
- Onshore & Offshore Platforms
- Steel Plants
- Solvent Extraction Plants
- Sewage
- Cooling Water
- Ship Yards & Marine Management
- LPG Bottling Plants
- Water Works
- Pulp & Paper
- Fertilizers
- Textiles
- Sugar
- Nuclear & Atomic Power Stations
- Paints & Varnishes
- Soaps & Detergents
- Slurry & Ash handling
- Food & Oil Industry
- Effluent & Water Treatment

This Product is Generally made to use on the High Pressure Piping System, It is Widely Applied for Major Industrial Sectors

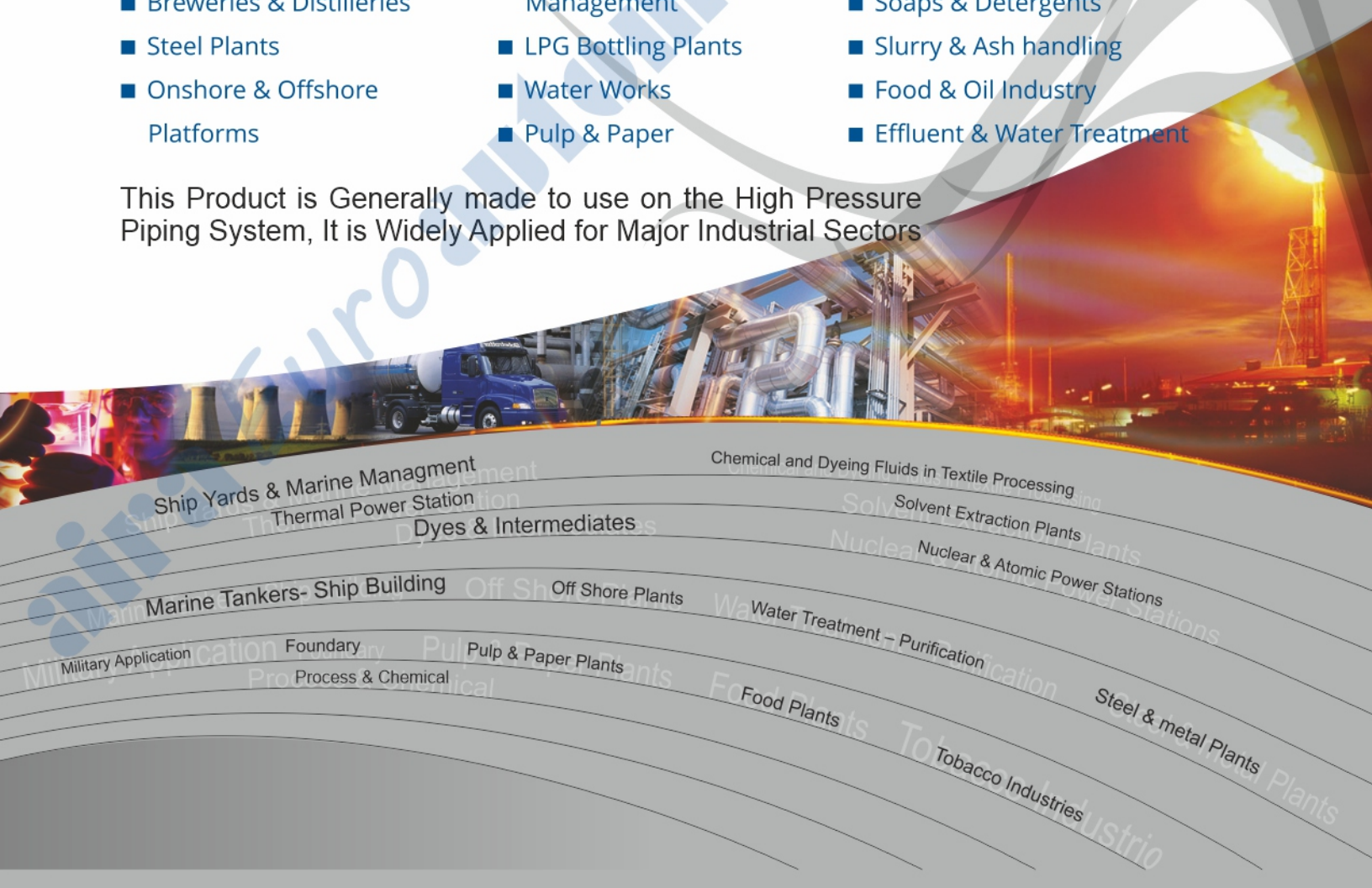

Ship Yards & Marine Management
Thermal Power Station

Dyes & Intermediates

Marine Tankers- Ship Building

Off Shore Plants

Military Application

Foundary

Pulp & Paper Plants

Water Treatment - Purification

Food Plants

Tobacco Industries

Steel & metal Plants

Chemical and Dyeing Fluids in Textile Processing

Solvent Extraction Plants

Nuclear & Atomic Power Stations



time tested designs with superior performance

GLOBAL Network

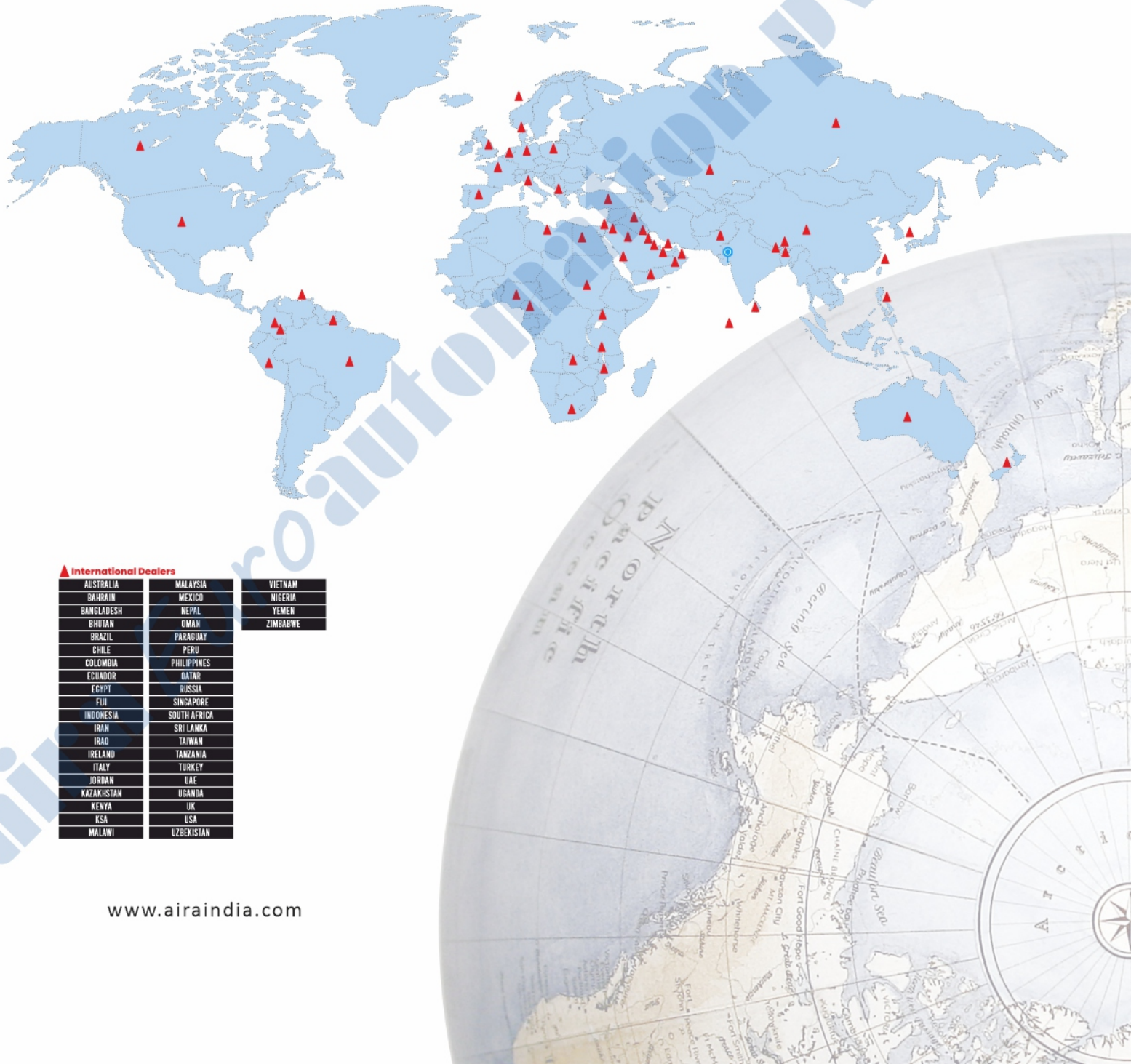

▲ International Dealers

AUSTRALIA	MALAYSIA	VIETNAM
BAHRAIN	MEXICO	NIGERIA
BANGLADESH	NEPAL	YEMEN
BHUTAN	OMAN	ZIMBABWE
BRAZIL	PARAGUAY	
CHILE	PERU	
COLOMBIA	PHILIPPINES	
ECUADOR	QATAR	
EGYPT	RUSSIA	
FUJI	SINGAPORE	
INDONESIA	SOUTH AFRICA	
IRAN	SRI LANKA	
IRAQ	TAIWAN	
IRELAND	TANZANIA	
ITALY	TURKEY	
JORDAN	UAE	
KAZAKHISTAN	UGANDA	
KENYA	UK	
KSA	USA	
MALAWI	UZBEKISTAN	



industrial valve automation

Network

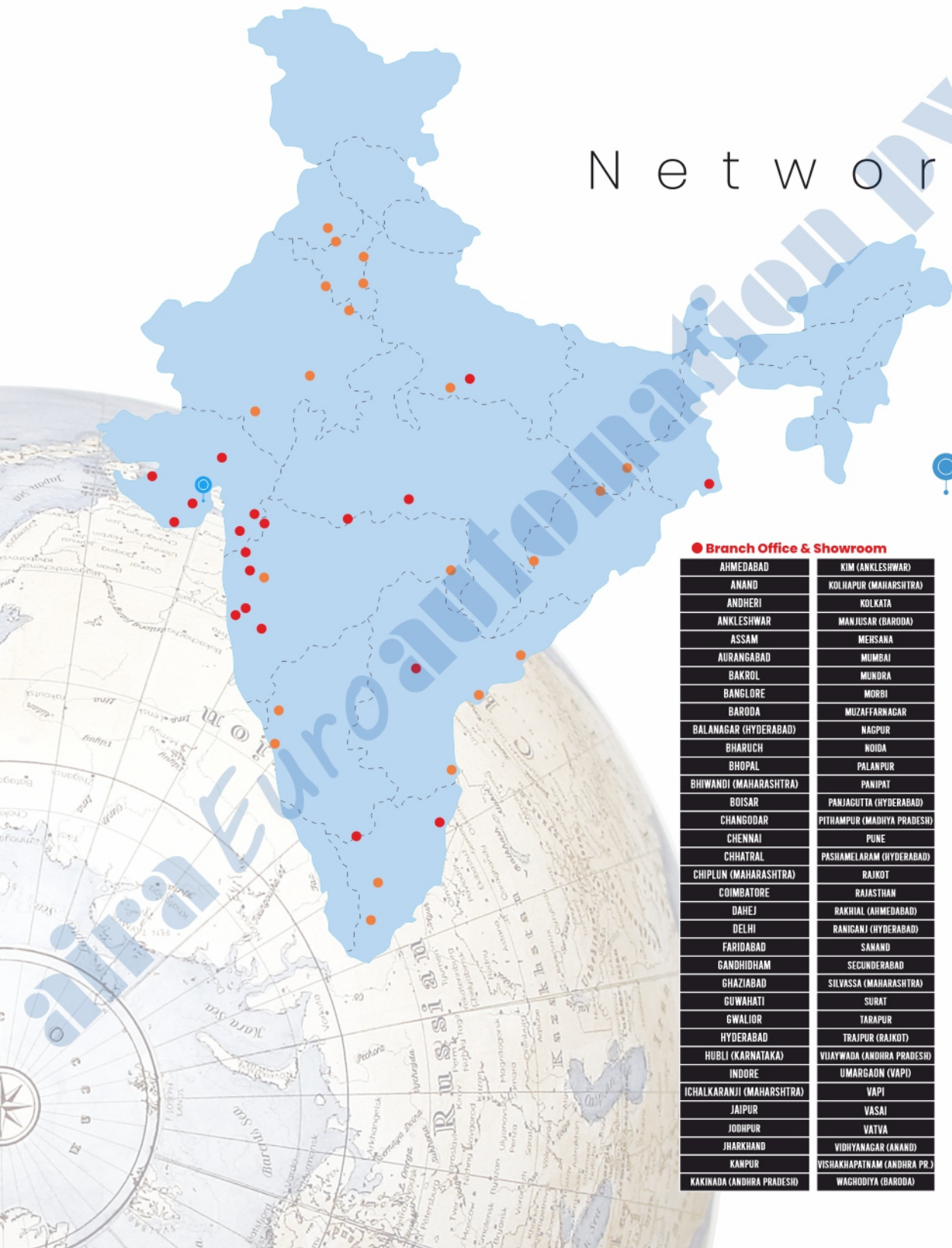

● Head Office & Works
AHMEDABAD

● Branch Office & Showroom

AHMEDABAD	KIM (ANKLESHWAR)
ANAND	KOLHAPUR (MAHARASHTRA)
ANDHERI	KOLKATA
ANKLESHWAR	MANJUSAR (BARODA)
ASSAM	MEHSANA
AURANGABAD	MUMBAI
BAKROL	MUNDRA
BANGLORE	MORBI
BARODA	MUZAFFARNAGAR
BALANAGAR (HYDERABAD)	NAGPUR
BHARUCH	NOIDA
BHOPAL	PALANPUR
BHIWANDI (MAHARASHTRA)	PANIPAT
BOISAR	PANJAGUTA (HYDERABAD)
CHANGODAR	PITHAMPUR (MADHYA PRADESH)
CHENNAI	PUNE
CHHATRAL	PASHAMELARAM (HYDERABAD)
CHIPLUN (MAHARASHTRA)	RAJKOT
COIMBATORE	RAJASTHAN
DAHEJ	RAKHIAL (AHMEDABAD)
DELHI	RANIGANJ (HYDERABAD)
FARIDABAD	SANAND
GANDHIDHAM	SECUNDERABAD
GHAZIABAD	SILVASSA (MAHARASHTRA)
GUWAHATI	SURAT
GWALIOR	TARAPUR
HYDERABAD	TRAJIPUR (RAJKOT)
HUBLI (KARNATAKA)	VIJAYWADA (ANDHRA PRADESH)
INDORE	UMARGAON (VAPI)
ICHALKARANJI (MAHARASHTRA)	VAPI
JAIPUR	VASAI
JODHPUR	VATVA
JHARKHAND	VIDHYANAGAR (ANAND)
KANPUR	VISHAKHAPATNAM (ANDHRA PR.)
KAKINADA (ANDHRA PRADESH)	WAGHOZIYA (BARODA)

● Dealers & Distributors

AMRITSAR	KOLKATA
BALOTA	LUCKNOW
BANGLORE	LUDHIANA
BELGAUM	MARWAR
BHILWARA	MEERUT
CHANDICARH	MUZAFFARNAGAR
CHENNAI	NAGPUR
COCHIN	NOIDA
COIMBATORE	PANIPAT
DELHI	PEENYA
ERODE	PUNE
FARIDABAD	TRIPUR
GHAZIABAD	VARANASI
GOA	VISAKHAPATNAM
INDORE	WADI
JALANDHAR	KANPUR
JAMSHEDPUR	KOLHAPUR
JHARKHAND	



Mfg. & Mkt by :

aira Euroautomation pvt. ltd.
INDIA

Available At :

