

Your Solution Partner In  
**Industrial Valve Automation...**



# Aluminum Pressure Die Cast **BUTTERFLY VALVE**



Mfg. & Mkt by :

**aira Euroautomation pvt. ltd.**  
INDIA



[www.airaindia.com](http://www.airaindia.com)



## About Us

*Clients are why we exist!*

We welcome and thank you for referring out detailed catalogue.

**aira** is know all over continents as a manufacturer of quality products - Ball Valves, Butterfly Valves, Plug Valves, & Control On / Off Valves with Pneumatic Actuators for Pharma, Oil & Gas, Steel, Paper, Water, Chemical and all type of processing industries.

**aira** has walked through more than 3 decades, gaining valuable experience, offering equipment's in the products manufactured by OEMs in all spheres of engineering. **aira** products have gained reputations of consultants, and approvals of users, OEMs and other as a quality product.

**aira** has expanding business into foreign markets specially GCC, UAE, Asian & African countries. This is because increase its customer base and revenue, leading to overall growth and success. Now foreign users come to know and believe in the services provided by the **aira**. Along with the same, it also helps to reach a large number of users thereby leading to the increase their business.

Being and ISO 9001 BVQI certified company has put **aira** in fore front. Out motto is "Value the customer" and "Superior product", one among the best in the world.

### Our Quality

- In- House full scale testing facility.
- Lean manufacturing practices
- Certified by : ISO 9001 : 2015 (BVQI LONDON), CE, ATEX, CIMFR, BIS, PESO, SIL 3, IBR
- API 609, API 6D

### Our Commitment

- To understand customer's need first before proposing our products.
- To keep on providing competitive rate's by adapting to continuous process improvement, without compromising on quality.
- To provide continuous support to our customers and go beyond their expectations in terms of delivery and after sale services.

### Our Manufacturing Facility

- In house R & D, manufacturing and testing facility is all located in a spread over three campuses at Ahmedabad, Gujarat, INDIA.

### Network - Sales Office

- 60 Plus Branch Offices in different states in India.
- Sales office in the Bangladesh, Dubai, Kenya, Malaysia, Nepal, Qatar, Singapore, South Africa, Sri Lanka, Turkey, USA (Expanding).

[www.airaindia.com](http://www.airaindia.com)



**QMS (Quality Management System)**

ISO 9001 : 2015

**EMS (Environment Management System)**

ISO 14001 : 2015

**OHSAS (Occupational Health & Safety Management System)**

ISO 45001 : 2018

**IBR**  
PISTON VALVE  
GLOBE CONTROL VALVE (CKD/CND)  
DISC CHECK VALVE (DCV)  
PRESSURE REDUCING VALVE (PRV)  
POP TYPE SAFETY VALVE  
BALL VALVE

**Pneumatic Actuator**

CE /  
ATEX /  
EXIDA SIL-3 /  
PROOF OF DESIGN

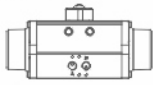

**Scotch & Yoke Actuator**

CE / ATEX / SIL-3

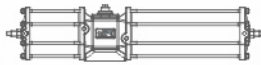

**Stainless Steel Actuator**

CE /  
IEP ATEX



**Positioner Enclosure**

CE / CIMFR /  
IP67 / BIS  
/ PESO

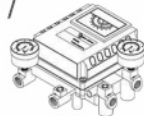

**aira's**  
**SOME OF OUR**  
*Certificates*

**Plug Valve**

FUGITIVE EMISSIONS  
TEST  
AS PER ISO  
15848-1 / IBR

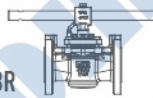

**Flameproof Solenoid Valve**

IEP ATEX / CE / CIMFR  
/ IP65 / IP67 / IP68 /  
BIS / PESO

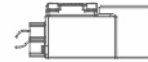

**Limit Switch**

IEP ATEX / CE / CIMFR  
/ IP67 / BIS / PESO /  
EQDC IP68

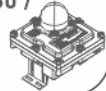

**Ball Valve (Floating & Trunnion)**

FIRE SAFE TEST DESIGN /  
FUGITIVE EMISSIONS TEST  
AS PER ISO 15848-1 / CE /  
PED /  
EXIDA SIL-3

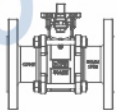

**Butterfly Valve (centric / Double & Triple Eccentric)**

FIRE SAFE TEST DESIGN /  
FUGITIVE EMISSIONS TEST  
AS PER ISO 15848-1 / CE /  
PED / EXIDA SIL-3  
/ IBR / PROOF OF DESIGN /  
FOOD GRADE / BIS / ISI



**Multiport Ball Valve**

FUGITIVE EMISSIONS TEST  
AS PER ISO 15848-1 / CE /  
PED / EIL

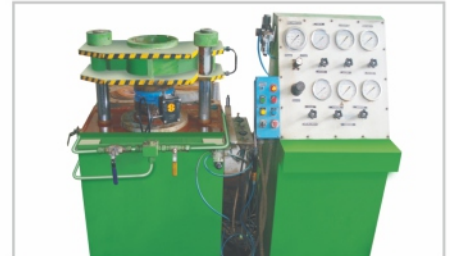
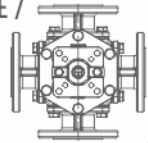

# Company Profile

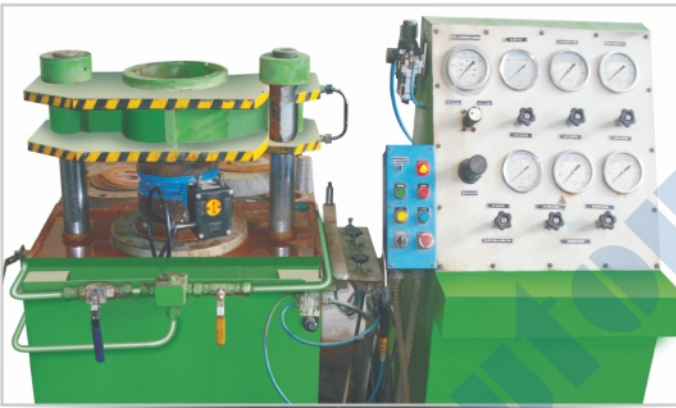

[www.airaindia.com](http://www.airaindia.com)



# Aluminum Pressure Die Cast Butterfly Valve



"aira" Offers A low weight wafer type valve (body:aluminium) which is optimally suited for applications with soft seating(Nitrile / EPDM) requirements. Suitable for all water application, like HVAC, Plumbing , Fire Fighting, Water Treatment Plant.

**Size Range : 1.1/2" to 12" ( 40 MM to 300 MM )**

## Standard

- Design And Manufacturer : API 609 Category A / BS 5155 / MSS SP - 67 / C - 504
- Valve Face to Face Dimensions : Short Wafer as per ISO 5752 Tab 5 API 609 Category A
- Top Flange Drilling : ISO 5211 II
- Flange Standard Conformity : ANSI 150, DIN PN 6 / 16
- Inspection & Testing : API 598 / BS EN - 12266 - 1

## Accessories

- On / OFF Indicator
- NAMUR Standard Solenoid Valve in all Standard Coil Voltage(Flame Proof Solenoid Coil - On Request)
- Pneumatic & Electro-Pneumatic valve positioner
- Declutchable Manual Over - Ride
- Limit Switches for On / Off Indication at Panel Boardn Filter + Regulator Combination with Pressure Gauge
- Air Lock Valve

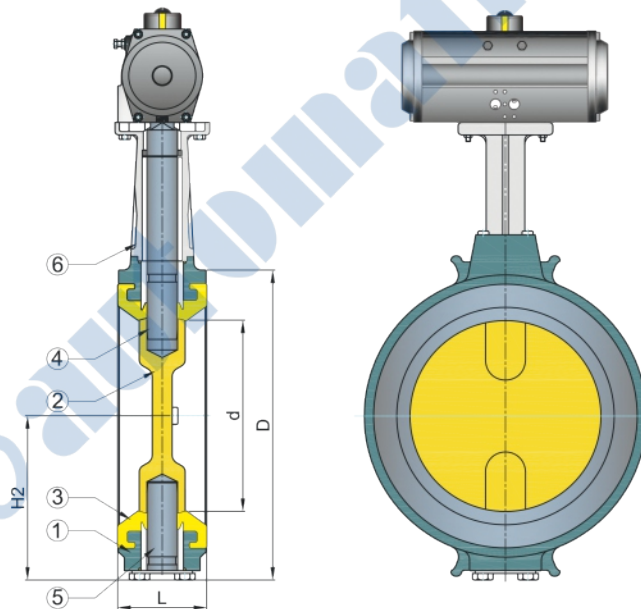

### Dimensions :

Valve Model	Valve Size		d	H2	L	D	Weight Approx.
	MM	Inch					
MKV - 40	40	1.1/2"	40	60	33	78	0.650
MKV - 50	50	2"	50	66	43	93	1.000
MKV - 65	65	2.1/2"	65	74	46	118	1.550
MKV - 80	80	3"	80	83	46	129	1.750
MKV - 100	100	4"	100	94	52	149	2.150
MKV - 125	125	5"	125	122	56	184	3.850
MKV - 150	150	6"	150	135	56	214	4.500
MKV - 200	200	8"	196	161	60	259	7.250
MKV - 250	250	10"	317	On Req.	72	On Req.	On Req.
MKV - 300	300	12"	371	On Req.	82	On Req.	On Req.

(All Dimensions are in mm)

Sr. No.	Description	Material
1	Body	Aluminum Pressure Die Cast
2	Disc	CF8M
3	Seat	EPDM
4	Top Shaft	S. S. 304
5	Bottom Shaft	S. S. 304
6	Bracket	Aluminum Pressure Die Cast

[www.airaindia.com](http://www.airaindia.com)



**Model :** APP-1200-L  
APP-1200-R

**"aira" Rotary / Liner Type Pneumatic - Pneumatic Valve Positioner**



**Input Signal** : 3 ~ 15psi (0.2-1.0 kgf/cm<sup>2</sup>)  
**Supply Air Pressure** : 100 psi Max. (7.0 kgf/cm<sup>2</sup>)  
**Standard Stroke** : 10 ~ 80mm  
**Air Piping Connection** : 1/4" NPT (F)  
**Temperature** : -20 °C to 70 °C  
**Pressure Gauge** : Stainless Steel  
**Explosion-Proof** : Ex 'd' II CT6  
**Degree of Protection** : IP66  
**Pressure Gauge** : Stainless Steel 0-2 kg/cm<sup>2</sup>  
 0-4 kg/cm<sup>2</sup> / 0-10 kg/cm<sup>2</sup>  
 : Rotary

**Output Characteristics**  
**Linearity** : Within ± 1.0% F.S.  
**Sensitivity** : Within 0.2% F.S.  
**Hysteresis** : Within 0.2% F.S.  
**Repeatability** : Within ± 0.75% F.S.  
**Air Consumption** : 5.0 LPM (1.4 kg/cm<sup>2</sup>) Supply  
**Flow Capacity** : 80 LPM (1.4 kg/cm<sup>2</sup>) Supply  
**Material** : Aluminium Die cast Body  
**Weight** : 1.8 Kg. (Approx)

IS / IEC 60079-1  
CML-3812155  
CIMFR  
CE  
CCEO Nagpur

**Model :** AEP-1000-L  
AEP-1000-R

**"aira" Rotary / Liner Flameproof cum Waeatherproof Electro Pneumatic Valve Positioner**



**Input Signal** : 4~20 mA DC  
**Input Resistance** : 235 ±15  
**Supply Air Pressure** : 20 ~ 100psi (7.0 kg/cm<sup>2</sup>)  
**Standard Stroke** : 10 ~ 80mm  
**Air Piping Connection** : 1/4" NPT (F)  
**Conduit Connection** : 1/2" NPT (F)  
**Explosion-proof** : Ex 'd' II CT6  
**Degree of Protection** : IP66  
**Temperature** : -20 °C to 70 °C  
**Pressure Gauge** : Stainless Steel 0-2 kg/cm<sup>2</sup>  
 0-4 kg/cm<sup>2</sup> / 0-10 kg/cm<sup>2</sup>  
**Output Characteristics** : Rotary  
**Linearity** : Within ± 1.0% F.S.  
**Sensitivity** : Within 0.2% F.S.  
**Hysteresis** : Within 0.75% F.S.  
**Repeatability** : Within ± 0.5% F.S.  
**Air Consumption** : 5.0 LPM (1.4 kg/cm<sup>2</sup>) Supply  
**Flow Capacity** : 80 LPM (1.4 kg/cm<sup>2</sup>) Supply  
**Material** : Alluminium Die Cast Body  
**Weight** : 2.8 Kg. With a terminal box

IS / IEC 60079-1  
CML-3812155  
CIMFR  
CE  
CCEO Nagpur

**"aira" Weatherproof Micro Limit Switch Box Dom Indicator Type On/Off Indicator**



**Type** : Mechanical Switch X 2 / Proximity Sensors P&F Make  
**Model Switch** : LA4 - FLP - 01  
 : Honywell V15 / Honywell V15 / NJ2-V3-N (Upto 8V) / NBB3-V3-Z4 (Upto 10 to 60 VDC)  
**Type Switch Rating** : 1 NO + 1 NC / 2 NO + 2 NC  
 : AC 250V 3A, 125V 5A & DC 250V 0.2A, 125V 0.4A, 30V 4A  
**Enclosure Protection** : IP 67  
**Temperature** : -20 °C ~ 80 °C  
**Conduit Entry** : NPT 1/2" (PT 1/2", PF 1/2, M20, PG 13.5)  
**Terminal Mounting Bracket** : 8 Points  
 : Namur VDI / VDE 3845, ISO 5211  
**Material** : Aluminum Pressure Die Cast

CIMFR  
CE  
CCEO Nagpur

**"aira" Flameproof Limit Switch Box**



**Type** : Mechanical Switch X 2 / Proximity Sensors P&F Make  
**Model Switch** : MLS - BX - FLP - 01  
 : Honywell V15 / Honywell V15 PCB Type / NJ2-V3-N (Upto 8V) / NBB3-V3-Z4 (Upto 10 to 60 VDC)  
**Type Switch Rating** : 1 NO + 1 NC / 2 NO + 2 NC  
 : AC 250V 3A, 125V 5A & DC 250V 0.2A, 125V 0.4A, 30V 4A  
**Enclosure Protection** : IP 67  
**Temperature** : -20 °C ~ 80 °C  
**Conduit Entry** : NPT 1/2" (PT 1/2", PF 1/2, M20, PG 13.5)  
**Terminal Mounting Bracket** : 8 Points  
 : Namur VDI / VDE 3845, ISO 5211  
**Material** : Aluminum Pressure Die Cast

IS / IEC 60079-1  
CML-3812155  
CIMFR  
CE  
CCEO Nagpur

**"aira" Flameproof Micro Limit Switch Box with Stainless Steel 304 / 316**



**Type** : Mechanical Switch X 2 / Proximity Sensors P&F Make  
**Model Switch** : LS4 - FLP-01  
 : Honywell V15 / Honywell V15 PCB Type / NJ2-V3-N (Upto 8V) / NBB3-V3-Z4 (Upto 10 to 60 VDC)  
**Type Switch Rating** : 1 NO + 1 NC / 2 NO + 2 NC  
 : AC 250V 3A, 125V 5A & DC 250V 0.2A, 125V 0.4A, 30V 4A  
**Enclosure Protection** : IP 67  
**Temperature** : -20 °C ~ 80 °C  
**Conduit Entry** : NPT 1/2" (PT 1/2", PF 1/2, M20, PG 13.5)  
**Terminal Mounting Bracket** : 8 Points  
 : Namur VDI / VDE 3845, ISO 5211  
**Material** : Stainless Steel 304 / 316

CIMFR  
CE  
CCEO Nagpur

**"aira" Weatherproof Limit Switch Box**



**Type** : Mechanical Switch X 2 / Proximity Sensors P&F Make  
**Model Switch** : MMLS - BX - WP - 01  
 : Honywell ZM / NJ2 - V3 - N (Upto 8 Voltage) / NBB - V3 - Z4 (Upto 10 to 60 VDC)  
**Type Switch Rating** : 1 NO + 1 NC  
 : AC 250V 3A, 125V 5A & DC 250V 0.2A, 125V 0.4A, 30V 4A  
**Enclosure Protection** : IP 67  
**Temperature** : -20 °C ~ 80 °C  
**Conduit Entry** : NPT 1/2" (PT 1/2", PF 1/2, M20, PG 13.5)  
**Terminal Mounting Bracket** : 8 Points  
 : Namur VDI / VDE 3845, ISO 5211  
**Material** : Aluminum Pressure Die Cast

CIMFR  
CE  
CCEO Nagpur

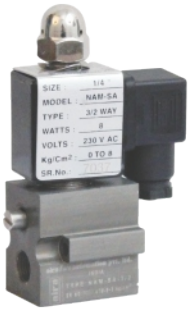

**“aira” 3/2 Way Namur Direct Acting Solenoid Valve**

Model	: NAM-SA-32
Coil Voltage	: All Std. Voltage Available
Frequency	: 50 - 60 Hz
Connection Type	: 1/4" (BSP / NPT)
Conduit	: PF 1/2"
Coil Insulation Grade	: Class "F"
Temperature	: -20 °C ~ 70 °C (-4 ~ 158 °F)
MOC	: Aluminium
Seals	: NBR ( Viton On Request )
Working Pressure	: Upto 8 BAR

This 3/2 Namur is suitable for actuator model : 5412-S / ARA-49S / ARA-50S



**“aira” 3/2 & 5/2 Way Convertible Poppet Type Single Namur Solenoid Valve**

Model	: OTX - PPT - 32 / OTX - PPT - 52
Coil Voltage	: All Std. Voltage Available
Frequency	: 50 - 60 Hz
Connection Type	: 1/4" (BSP / NPT)
Conduit	: PF 1/2"
Coil Insulation Grade	: Class "F"
Temperature	: -20 °C ~ 70 °C (-4 ~ 158 °F)
MOC	: Aluminium
Seals	: NBR ( Viton On Request )
Working Pressure	: Upto 8 BAR

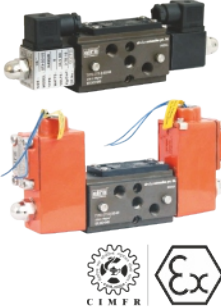

**“aira” 3/2 & 5/2 Way Convertible Poppet Type Double Namur Solenoid Valve**

Model	: 2OTX - PPT - 52
Coil Voltage	: All Std. Voltage Available
Frequency	: 50 - 60 Hz
Connection Type	: 1/4" (BSP / NPT)
Conduit	: PF 1/2"
Coil Insulation Grade	: Class "F"
Temperature	: -20 °C ~ 70 °C (-4 ~ 158 °F)
MOC	: Aluminium
Seals	: NBR ( Viton On Request )
Working Pressure	: Upto 8 BAR



**“aira” 3/2 & 5/2 Way Convertible Spool Type Single Namur Solenoid Valve**

Model	: AMV-NAM-220
Coil Voltage	: All Std. Voltage Available
Frequency	: 50 - 60 Hz
Connection Type	: 1/4" (BSP / NPT)
Conduit	: PF 1/2"
Coil Insulation Grade	: Class "F"
Temperature	: -20 °C ~ 70 °C (-4 ~ 158 °F)
Body Material	: Aluminium
Seals	: NBR ( Viton On Request )
Working Pressure	: Upto 8 BAR



**“aira” 3/2 & 5/2 Way Convertible Spool Type Double Namur Solenoid Valve**

Model	: 2AMV-NAM-220
Coil Voltage	: All Std. Voltage Available
Frequency	: 50 - 60 Hz
Connection Type	: 1/4" (BSP / NPT)
Conduit	: PF 1/2"
Coil Insulation Grade	: Class "F"
Temperature	: -20 °C ~ 70 °C (-4 ~ 158 °F)
Body Material	: Aluminium
Seals	: NBR ( Viton On Request )
Working Pressure	: Upto 8 BAR



**“aira” AJ Series 3/2 Way Direct Acting Solenoid Valve (Normally Open & Closed)**

Model	: AIDS-09-202
Size	: 1/4" BSP
Body	: Aluminium Pressure Die Cast
Orifice	: 2 MM
Pressure	: 7 Kg/cm <sup>2</sup> / 10 Kg/cm <sup>2</sup>
Temp.	: Upto 50 °C
Leakage	: Bubble Tight
Frequency	: 50 ~ 60 Hz
Coil Insulation Grade	: Class "F"
Media	: Air (Filtered & Lubricated)
Voltage	: All Std. Voltage Available



**“aira” Filter + Regulator Air Combination**

Model	: 4FQ / 8 FQ / FRJ
Air Connection	: 1/4" BSP
Max. Supply Pressure	: 4FQ: 0.5 to 4 Kg/cm <sup>2</sup> 8FQ: 0.5 to 8 Kg/cm <sup>2</sup> 1 to 9 Kg/cm <sup>2</sup>
Gauge Connection	: 1/8"
Ambient Temperature	: -20 °C ~ 120 °C (High Temp.) -40 °C ~ 120 °C (low Temp.)
Mini Filtering Size	: 5 Micron
Material	: Aluminium Pressure Die Cast

(4FQ / 8FQ) (FRJ)



**“aira” Air Volume Booster**

Model	: VLB
Size	: 1/4" to 1" BSP
MOC	: Aluminium / S. S. 304 / 316
Seals	: NBR
Max. Supply Pressure	: Max. 1Mpa (10 Bar)
Max. Output Pressure	: Max. 0.7 Mpa (7 Bar)
Temperature	: -20 °C ~ 70 °C (Standard) -20 °C ~ 120 °C (High) -40 °C ~ 70 °C (Low)
Linearity	: 1 : 1
Hysteresis	: 1%



**“aira” Single & Double Air Lock Valve**

Model	: SALV / DALV
Material	: Aluminum / Stainless Steel 304
Max. Supply Pressure	: Max. 10.2 Kg/cm <sup>2</sup> ( 142 PSI )
Max. Single Pressure	: Max. 7.1 Kg/cm <sup>2</sup> ( 1000 PSI )
Setting Pressure Range	: 1.4-7.1 Kg/cm <sup>2</sup> ( 20 ~ 100 PSI )
Flow Capacity (Cv)	: 0.9
In/Output Port Connection	: 1/4" NPT
Signal Port Connection	: 1/4" NPT
Differential Pressure	: Below 0.1 Kg/cm <sup>2</sup> ( 1.4 PSI )
Hysteresis	: 1%
ambient Temp.	: -20 °C ~ 70 °C

DALV SALV



**“aira” Manual Override Clutch Type (MO)**

Model	: AMO
Torque	: 200 Nm to 10000 Nm
Body	: Aluminium Pressure Die Cast / S. G. Iron
Lever Wheel	: Stainless Steel
Hand Wheel	: S. S. / M. S. (Fabricated)

## Installations

- Indian Oil
- Reliance Industries Limited
- ONGC
- Hindalco
- Godrej
- Indian Railway
- Vedanta
- Voltas
- NTPC
- Gujarat State Fertilizers & Chemical Ltd.
- L & T
- Gail
- Hindustan Petroleum
- BHEL
- IFFCO
- BARC
- Thermax
- Essar

## Application

- Process & Chemical
- Refineries & Petrochemicals
- Drugs & Pharmaceuticals
- Thermal Power Stations
- Dyes & Intermediates
- Breweries & Distilleries
- Steel Plants
- Onshore & Offshore Platforms
- Steel Plants
- Solvent Extraction Plants
- Sewage
- Cooling Water
- Ship Yards & Marine Management
- LPG Bottling Plants
- Water Works
- Pulp & Paper
- Fertilizers
- Textiles
- Sugar
- Nuclear & Atomic Power Stations
- Paints & Varnishes
- Soaps & Detergents
- Slurry & Ash handling
- Food & Oil Industry
- Effluent & Water Treatment

This Product is Generally made to use on the High Pressure Piping System, It is Widely Applied for Major Industrial Sectors

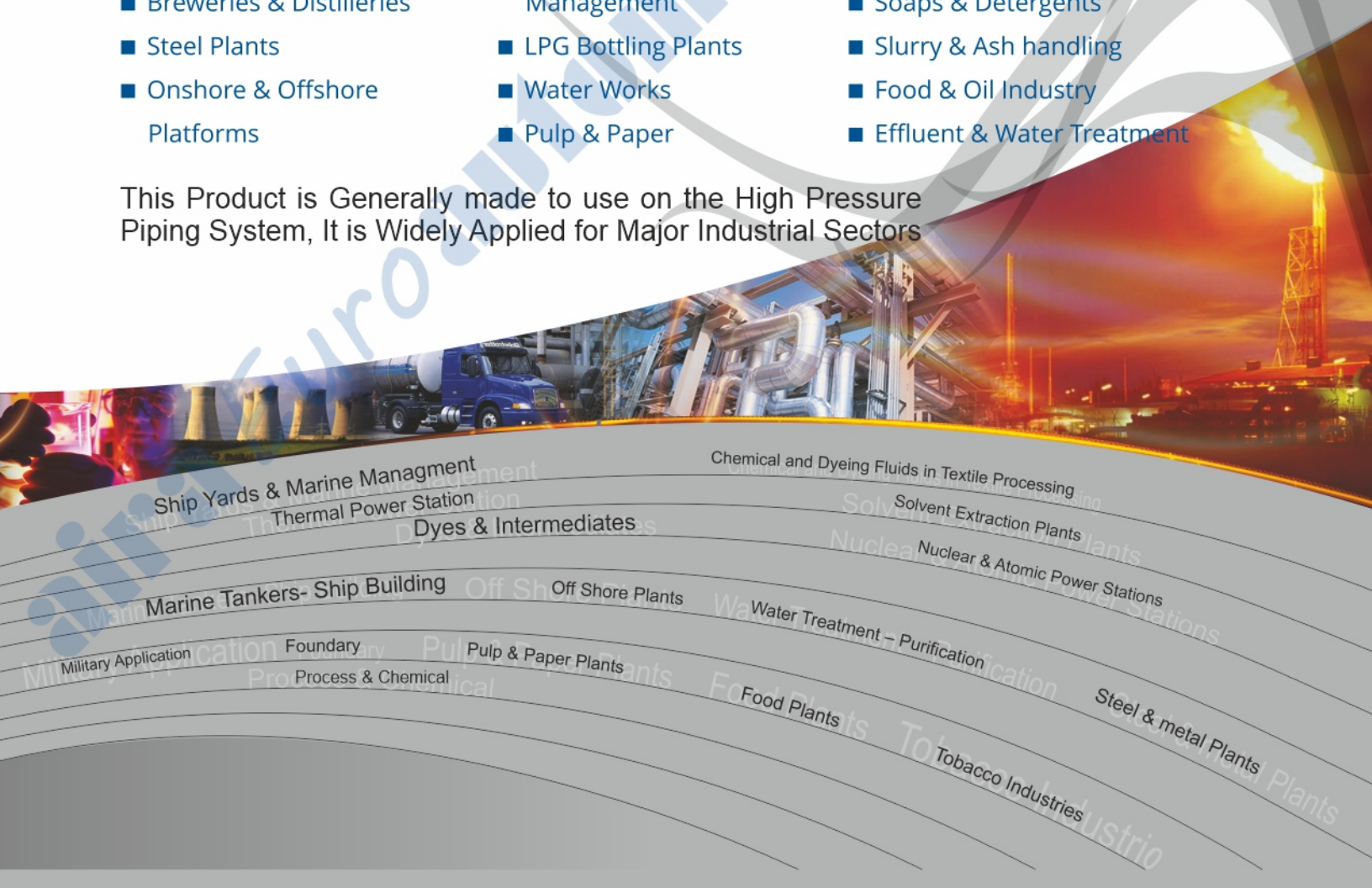

Ship Yards & Marine Management  
Thermal Power Station

Dyes & Intermediates

Marine Tankers- Ship Building

Off Shore Plants

Military Application

Foundary

Pulp & Paper Plants

Water Treatment - Purification

Food Plants

Steel & metal Plants

Tobacco Industries

Plants





*time tested designs with superior performance*

# GLOBAL

Network

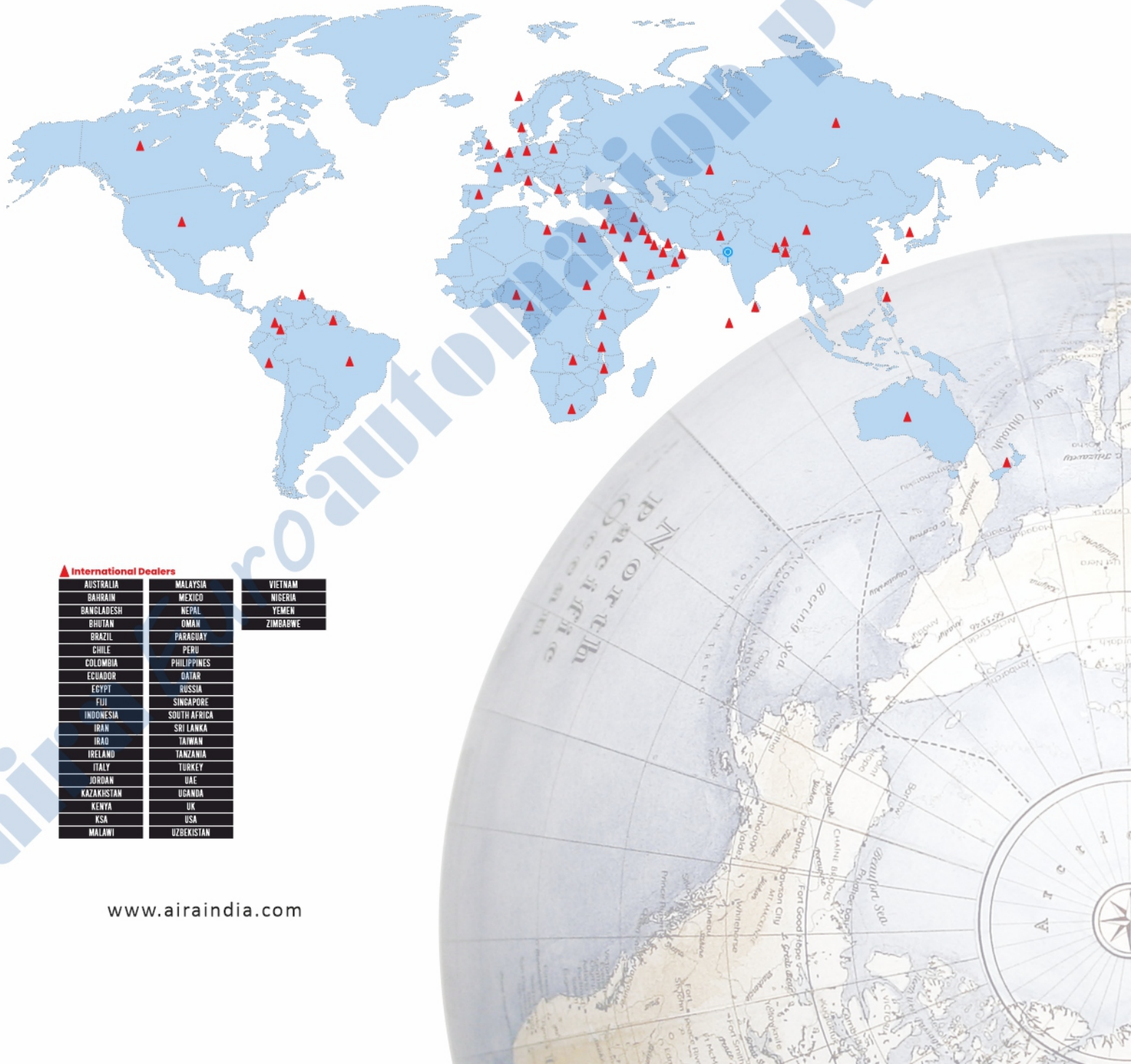

**▲ International Dealers**

AUSTRALIA	MALAYSIA	VIETNAM
BAHRAIN	MEXICO	NIGERIA
BANGLADESH	NEPAL	YEMEN
BHUTAN	OMAN	ZIMBABWE
BRAZIL	PARAGUAY	
CHILE	PERU	
COLOMBIA	PHILIPPINES	
ECUADOR	QATAR	
EGYPT	RUSSIA	
FUJI	SINGAPORE	
INDONESIA	SOUTH AFRICA	
IRAN	SRI LANKA	
IRAQ	TAIWAN	
IRELAND	TANZANIA	
ITALY	TURKEY	
JORDAN	UAE	
KAZAKHISTAN	UGANDA	
KENYA	UK	
KSA	USA	
MALAWI	UZBEKISTAN	



*industrial valve automation*

# Network

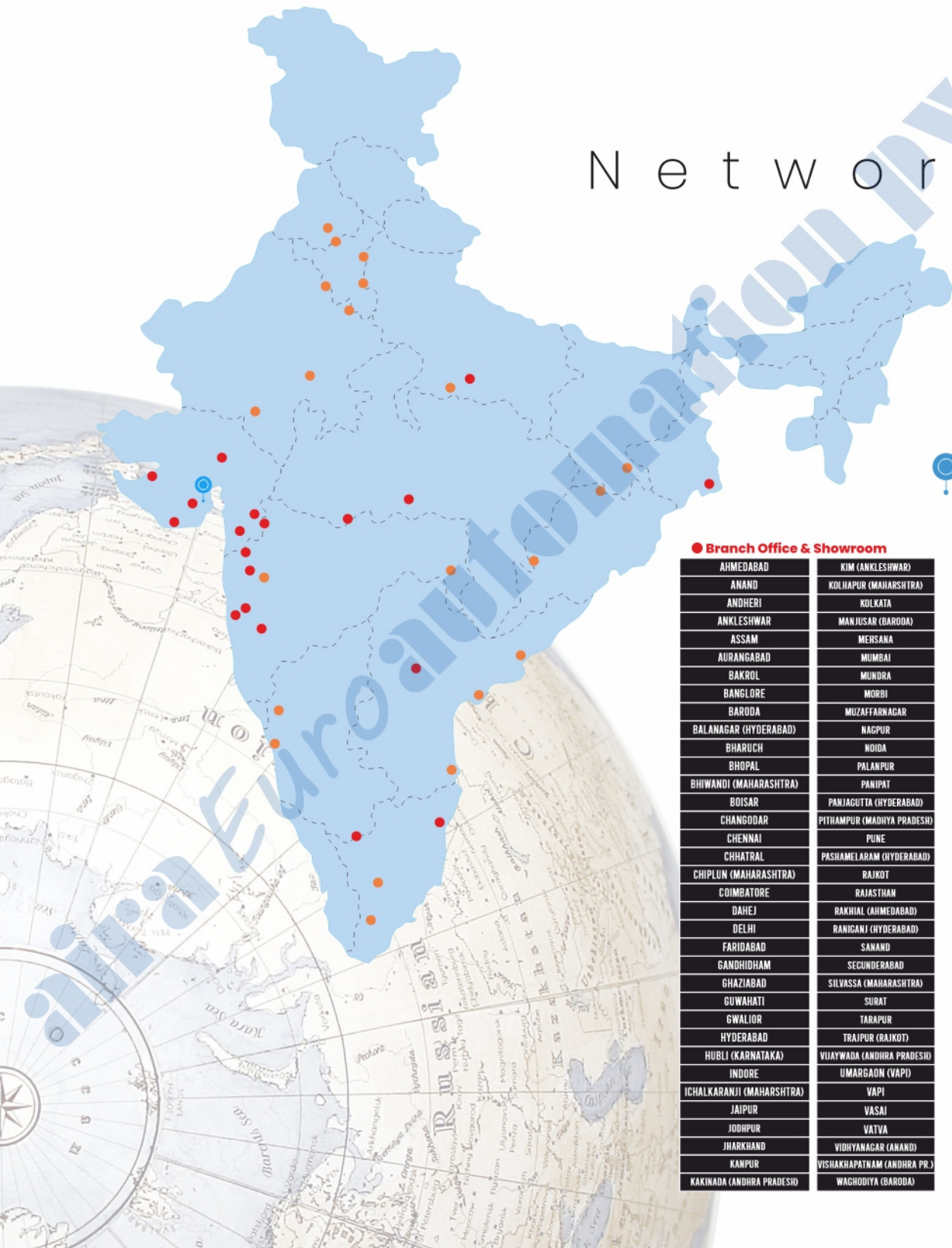

 Head Office & Works  
AHMEDABAD

**● Branch Office & Showroom**

AHMEDABAD	KIM (ANKLESHWAR)
ANAND	KOLHAPUR (MAHARASHTRA)
ANDHERI	KOLKATA
ANKLESHWAR	MANJUSAR (BARODA)
ASSAM	MEHSANA
AURANGABAD	MUMBAI
BAKROL	MUNDRA
BANGLORE	MORBI
BARODA	MUZAFFARNAGAR
BALANAGAR (HYDERABAD)	NAGPUR
BHARUCH	NOIDA
BHOPAL	PALANPUR
BHIWANDI (MAHARASHTRA)	PANIPAT
BOISAR	PANJAGUTA (HYDERABAD)
CHANGODAR	PITHAMPUR (MADHYA PRADESH)
CHENNAI	PUNE
CHHATRAL	PASHAMELARAM (HYDERABAD)
CHIPLUN (MAHARASHTRA)	RAJKOT
COIMBATORE	RAJASTHAN
DAHEJ	RAKHIAL (AHMEDABAD)
DELHI	RANIGANJ (HYDERABAD)
FARIDABAD	SANAND
GANDHIDHAM	SECUNDERABAD
GHAZIABAD	SILVASSA (MAHARASHTRA)
GUWAHATI	SURAT
GWALIOR	TARAPUR
HYDERABAD	TRAJIPUR (RAJKOT)
HUBLI (KARNATAKA)	VIJAYWADA (ANDHRA PRADESH)
INDORE	UMARGAON (VAPI)
ICHALKARANJI (MAHARASHTRA)	VAPI
JAIPUR	VASAI
JODHPUR	VATVA
JHARKHAND	VIDHYANAGAR (ANAND)
KANPUR	VISHAKHAPATNAM (ANDHRA PR.)
KAKINADA (ANDHRA PRADESH)	WAGHODIYA (BARODA)

**● Dealers & Distributors**

AMRITSAR	KOLKATA
BALOTA	LUCKNOW
BANGLORE	LUDHIANA
BELGAUM	MARWAR
BHILWARA	MEERUT
CHANDICARH	MUZAFFARNAGAR
CHENNAI	NAGPUR
COCHIN	NOIDA
COIMBATORE	PANIPAT
DELHI	PEENYA
ERODE	PUNE
FARIDABAD	TRIPUR
GHAZIABAD	VARANASI
GOA	VISAKHAPATNAM
INDORE	WADI
JALANDHAR	KANPUR
JAMSHEDPUR	KOLHAPUR
JHARKHAND	

Mfg. & Mkt by :

**aira Euroautomation pvt. ltd.**  
INDIA

Available At :