

Your Solution Partner In
Industrial Valve Automation...

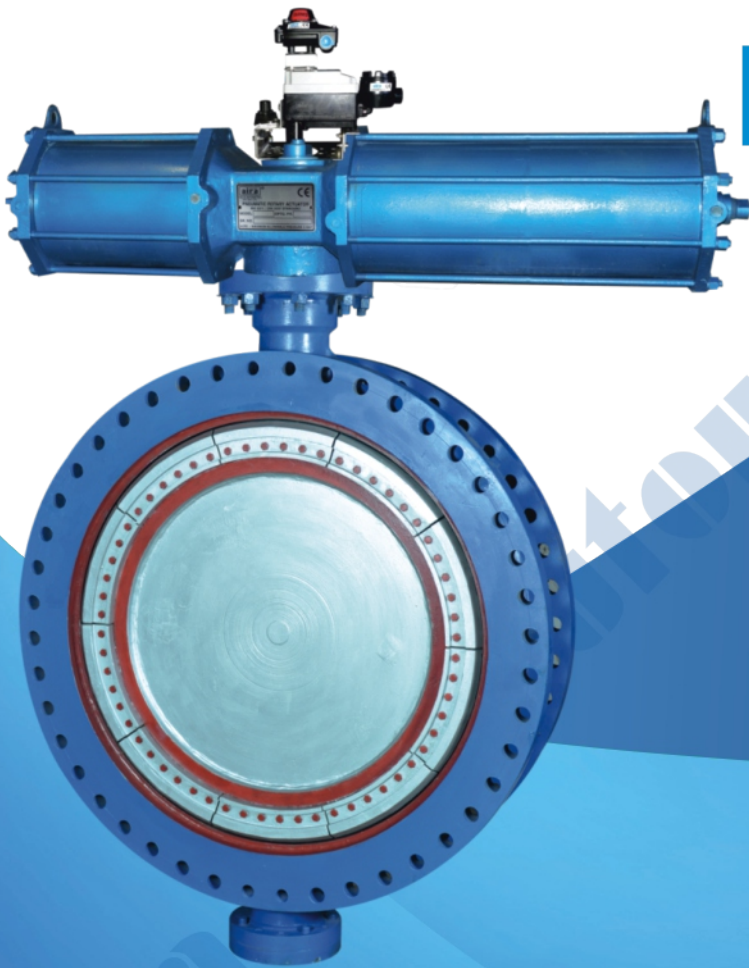

AWWA C - 504 & AWWA C - 516 Standard Large Diameter Double Flange **BUTTERFLY VALVE**



Mfg. & Mkt by :

aira Euroautomation pvt. ltd.
INDIA



www.airaindia.com



About Us

Clients are why we exist!

We welcome and thank you for referring out detailed catalogue.

aira is know all over continents as a manufacturer of quality products - Ball Valves, Butterfly Valves, Plug Valves, & Control On / Off Valves with Pneumatic Actuators for Pharma, Oil & Gas, Steel, Paper, Water, Chemical and all type of processing industries.

aira has walked through more than 3 decades, gaining valuable experience, offering equipment's in the products manufactured by OEMs in all spheres of engineering. **aira** products have gained reputations of consultants, and approvals of users, OEMs and other as a quality product.

aira has expanding business into foreign markets specially GCC, UAE, Asian & African countries. This is because increase its customer base and revenue, leading to overall growth and success. Now foreign users come to know and believe in the services provided by the **aira**. Along with the same, it also helps to reach a large number of users thereby leading to the increase their business.

Being and ISO 9001 BVQI certified company has put **aira** in fore front. Out motto is "Value the customer" and "Superior product", one among the best in the world.

Our Quality

- In- House full scale testing facility.
- Lean manufacturing practices
- Certified by : ISO 9001 : 2015 (BVQI LONDON), CE, ATEX, CIMFR, BIS, PESO, SIL 3, IBR
- API 609, API 6D

Our Commitment

- To understand customer's need first before proposing our products.
- To keep on providing competitive rate's by adapting to continuous process improvement, without compromising on quality.
- To provide continuous support to our customers and go beyond their expectations in terms of delivery and after sale services.

Our Manufacturing Facility

- In house R & D, manufacturing and testing facility is all located in a spread over three campuses at Ahmedabad, Gujarat, INDIA.

Network - Sales Office

- 60 Plus Branch Offices in different states in India.
- Sales office in the Bangladesh, Dubai, Kenya, Malaysia, Nepal, Qatar, Singapore, South Africa, Sri Lanka, Turkey, USA (Expanding).

www.airaindia.com





CERTIFICATIONS

Approvals

QMS (Quality Management System)
ISO 9001 : 2015

EMS (Environment Management System)
ISO 14001 : 2015

OHSAS (Occupational Health & Safety Management System)
ISO 45001 : 2018

IBR
PISTON VALVE
GLOBE CONTROL VALVE (CKD/CND)
DISC CHECK VALVE (DCV)
PRESSURE REDUCING VALVE (PRV)
POP TYPE SAFETY VALVE
BALL VALVE

Pneumatic Actuator
CE / ATEX / EXIDA SIL-3 / PROOF OF DESIGN

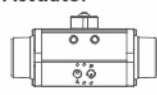

Scotch & Yoke Actuator
CE / ATEX / SIL-3

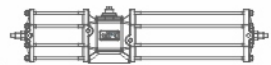

Stainless Steel Actuator
CE / IEP ATEX



Positioner Enclosure
CE / CIMFR / IP67 / BIS / PESO



aira's SOME OF OUR Certificates

Plug Valve
FUGITIVE EMISSIONS TEST
AS PER ISO 15848-1 / IBR

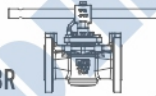

Flameproof Solenoid Valve
IEP ATEX / CE / CIMFR / IP65 / IP67 / IP68 / BIS / PESO

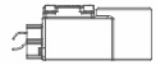

Limit Switch
IEP ATEX / CE / CIMFR / IP67 / BIS / PESO / EQDC IP68



Ball Valve (Floating & Trunnion)
FIRE SAFE TEST DESIGN / FUGITIVE EMISSIONS TEST
AS PER ISO 15848-1 / CE / PED / EXIDA SIL-3

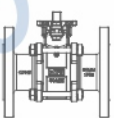

Butterfly Valve (centric / Double & Triple Eccentric)
FIRE SAFE TEST DESIGN / FUGITIVE EMISSIONS TEST
AS PER ISO 15848-1 / CE / PED / EXIDA SIL-3 / IBR / PROOF OF DESIGN / FOOD GRADE / BIS / ISI



Multiport Ball Valve
FUGITIVE EMISSIONS TEST
AS PER ISO 15848-1 / CE / PED / EIL

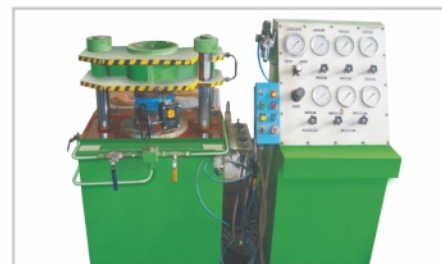
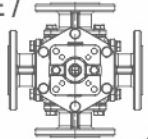

www.airaindia.com



Company Profile

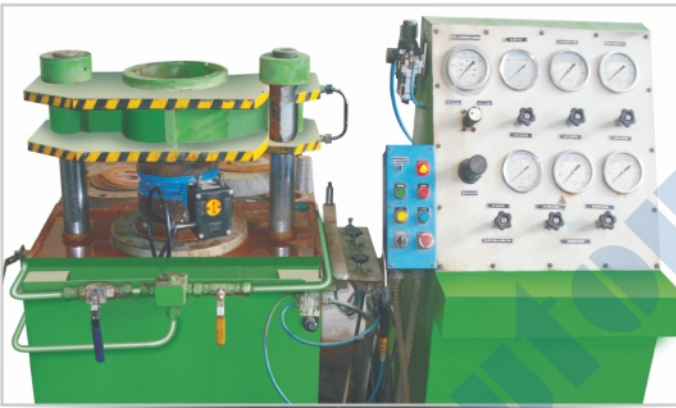

www.airaindia.com



AWWA C - 504 & AWWA C - 516 Standard Large Diameter Double Flange Butterfly Valve

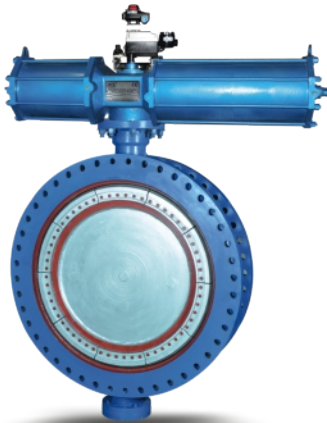

"aira" Offers Double-offset flanged butterfly valve (resilient-seated) according to the AWWA C504 standard. Long service life, as the medium does not come into contact with the bearing, and due to the wear-resistant, corrosion and infiltration-proof seat with weld overlay. Suitable for use water distribution, water treatment, pretreated waste water, dams, power plants, industry and pressure management.

**Size Range : 50" to 104" (1250 MM to 2600 MM)
(12" to 48" On Request)**

Standard

- Design And Manufacturer : AWWA C-504 / AWWA - C-516
- Valve Face to Face Dimensions Upto 72" : AWWA C-504 / AWWA - C-516
- Valve Face to Face Dimensions Upto 72" : As Per Manufacturer Standard
- Flange Standard Conformity : AWWA C-207 Class "D" / Class "B"
- Inspection & Testing : AWWA C-504
- Pressure Rating : PN 2.5 / PN 6 / PN 10 / PN 16
- Leakage Class : VI (Six)

PN 6 Pressure / Temperature Rating

Testing	Body	Seat
Hydraulic	9 Kg/cm ²	6.6 Kg/cm ²

Pressure / Temperature Rating

Pressure Rating	PN 10 / PN 6
Operating Temperature	-50 °C to +180 °C

PN 10 Pressure / Temperature Rating

Testing	Body	Seat
Hydraulic	15 Kg/cm ²	11 Kg/cm ²
Pneumatic	7 Kg/cm ²	

Sr. No.	Description	Material
1	Body	IS 2062 Gr. B M. S.
2	Disc	IS 2062 Gr. B M. S.
3	Retainer	IS 2062 Gr. B / ASTM A - 240
		ASTM A - 351 Gr. CF8 / CF8M
4	Body Seat Ring	ASTM A - 479 Type 304 / 316
5	Disc Seal Ring	EPDM / NBR / Viton
6	Shaft	ASTM A - 479 Type 410 / 304 / 316
7	Stem Shaft	ASTM A - 479 Type 410 / 304 / 316
8	Disc Pin	ASTM A - 479 Type 410 / 304 / 316
9	Bearing	Double Thrust Bearing
10	Guide Bush	Bronze
11	Seal Set	EPDM / NBR / Viton
12	Gland Plate	M. S.
13	Stem Plate	IS 2062 Gr. B
14	Actuator	STD.

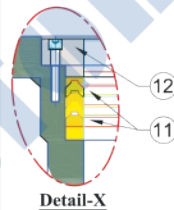
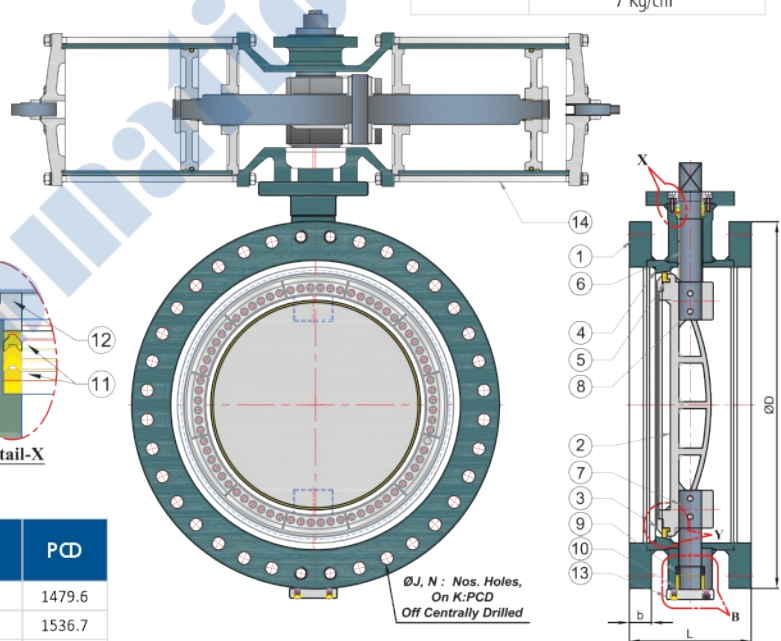

Dimensions :

Valve Size		L	ØD	b	ØJ	N	PCD
MM	Inch						
1250	50"	381	1568.5	51	44.45	44	1479.6
1300	52"	381	1626	51	44.45	44	1536.7
1350	54"	381	1682.8	54	44.45	44	1593.8
1400	56"	381	1770	57.15	44.45	52	1670
1500	60"	381	1854.2	57.15	44.45	52	1758.95
1600	64"	381	1915	60	44.45	52	1820
1650	66"	457	2032	63.5	44.45	52	1930.4
1800	72"	457	2197.1	66.5	44.45	60	2095.5
1950	78"	457	2362.2	69.9	50.8	64	2260.6
2000	80"	457	2449	70	50.8	64	2342
2100	84"	457	2533.7	73	50.8	64	2425.7
2200	88"	457	2800	77	58	68	2673.5
2400	96"	533	2876.6	82.6	58	68	2755.9
2500	100"	610	3048	82.6	63.5	72	2908.3
2600	104"	610	3138	86	63.5	72	2994

Upto 3 Meter On Request.

(All Dimensions are in mm)

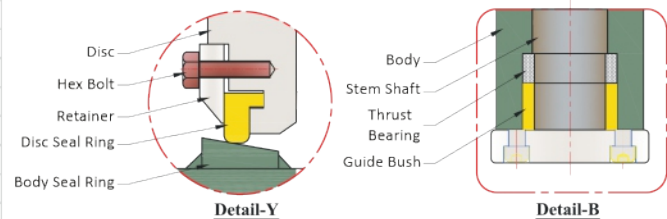

www.airaindia.com



Model : APP-1200-L
APP-1200-R

"aira" Rotary / Liner Type Pneumatic - Pneumatic Valve Positioner



Input Signal : 3 ~ 15psi (0.2-1.0 kgf/cm²)
Supply Air Pressure : 100 psi Max. (7.0 kgf/cm²)
Standard Stroke : 10 ~ 80mm
Air Piping Connection : 1/4" NPT (F)
Temperature : -20 °C to 70 °C
Pressure Gauge : Stainless Steel
Explosion-Proof : Ex 'd' II CT6
Degree of Protection : IP66
Pressure Gauge : Stainless Steel 0-2 kg/cm²
 0-4 kg/cm² / 0-10 kg/cm²
 : Rotary

Output Characteristics
Linearity : Within ± 1.0% F.S.
Sensitivity : Within 0.2% F.S.
Hysteresis : Within 0.2% F.S.
Repeatability : Within ± 0.75% F.S.
Air Consumption : 5.0 LPM (1.4 kg/cm²) Supply
Flow Capacity : 80 LPM (1.4 kg/cm²) Supply
Material : Aluminium Die cast Body
Weight : 1.8 Kg. (Approx)

IS / IEC 60079-1
CML-3812155
CIMFR
CE
CCEO Nagpur

Model : AEP-1000-L
AEP-1000-R

"aira" Rotary / Liner Flameproof cum Waeatherproof Electro Pneumatic Valve Positioner



Input Signal : 4~20 mA DC
Input Resistance : 235 ±15
Supply Air Pressure : 20 ~ 100psi (7.0 kg/cm²)
Standard Stroke : 10 ~ 80mm
Air Piping Connection : 1/4" NPT (F)
Conduit Connection : 1/2" NPT (F)
Explosion-proof : Ex 'd' II CT6
Degree of Protection : IP66
Temperature : -20 °C to 70 °C
Pressure Gauge : Stainless Steel 0-2 kg/cm²
 0-4 kg/cm² / 0-10 kg/cm²
Output Characteristics : Rotary
Linearity : Within ± 1.0% F.S.
Sensitivity : Within 0.2% F.S.
Hysteresis : Within 0.75% F.S.
Repeatability : Within ± 0.5% F.S.
Air Consumption : 5.0 LPM (1.4 kg/cm²) Supply
Flow Capacity : 80 LPM (1.4 kg/cm²) Supply
Material : Alluminium Die Cast Body
Weight : 2.8 Kg. With a terminal box

IS / IEC 60079-1
CML-3812155
CIMFR
CE
CCEO Nagpur

"aira" Weatherproof Micro Limit Switch Box Dom Indicator Type On/Off Indicator



Type : Mechanical Switch X 2 / Proximity Sensors P&F Make
Model : LA4 - FLP - 01
Switch : Honywell V15 / Honywell V15 / NJ2-V3-N (Upto 8V) / NBB3-V3-Z4 (Upto 10 to 60 VDC)
Type : 1 NO + 1 NC / 2 NO + 2 NC
Switch Rating : AC 250V 3A, 125V 5A & DC 250V 0.2A, 125V 0.4A, 30V 4A
Enclosure Protection : IP 67
Temperature : -20 °C ~ 80 °C
Conduit Entry : NPT 1/2" (PT 1/2", PF 1/2, M20, PG 13.5)
Terminal Mounting Bracket : 8 Points
 : Namur VDI / VDE 3845, ISO 5211
Material : Aluminum Pressure Die Cast

IS / IEC 60079-1
CML-3812155
CIMFR
CE
CCEO Nagpur

"aira" Flameproof Limit Switch Box



Type : Mechanical Switch X 2 / Proximity Sensors P&F Make
Model : MLS - BX - FLP - 01
Switch : Honywell V15 / Honywell V15 PCB Type / NJ2-V3-N (Upto 8V) / NBB3-V3-Z4 (Upto 10 to 60 VDC)
Type : 1 NO + 1 NC / 2 NO + 2 NC
Switch Rating : AC 250V 3A, 125V 5A & DC 250V 0.2A, 125V 0.4A, 30V 4A
Enclosure Protection : IP 67
Temperature : -20 °C ~ 80 °C
Conduit Entry : NPT 1/2" (PT 1/2", PF 1/2, M20, PG 13.5)
Terminal Mounting Bracket : 8 Points
 : Namur VDI / VDE 3845, ISO 5211
Material : Aluminum Pressure Die Cast

IS / IEC 60079-1
CML-3812155
CIMFR
CE
CCEO Nagpur

"aira" Flameproof Micro Limit Switch Box with Stainless Steel 304 / 316



Type : Mechanical Switch X 2 / Proximity Sensors P&F Make
Model : LS4 - FLP-01
Switch : Honywell V15 / Honywell V15 PCB Type / NJ2-V3-N (Upto 8V) / NBB3-V3-Z4 (Upto 10 to 60 VDC)
Type : 1 NO + 1 NC / 2 NO + 2 NC
Switch Rating : AC 250V 3A, 125V 5A & DC 250V 0.2A, 125V 0.4A, 30V 4A
Enclosure Protection : IP 67
Temperature : -20 °C ~ 80 °C
Conduit Entry : NPT 1/2" (PT 1/2", PF 1/2, M20, PG 13.5)
Terminal Mounting Bracket : 8 Points
 : Namur VDI / VDE 3845, ISO 5211
Material : Stainless Steel 304 / 316

IS / IEC 60079-1
CML-3812155
CIMFR
CE
CCEO Nagpur

"aira" Weatherproof Limit Switch Box



Type : Mechanical Switch X 2 / Proximity Sensors P&F Make
Model : MMLS - BX - WP - 01
Switch : Honywell ZM / NJ2 - V3 - N (Upto 8 Voltage) / NBB - V3 - Z4 (Upto 10 to 60 VDC)
Type : 1 NO + 1 NC
Switch Rating : AC 250V 3A, 125V 5A & DC 250V 0.2A, 125V 0.4A, 30V 4A
Enclosure Protection : IP 67
Temperature : -20 °C ~ 80 °C
Conduit Entry : NPT 1/2" (PT 1/2", PF 1/2, M20, PG 13.5)
Terminal Mounting Bracket : 8 Points
 : Namur VDI / VDE 3845, ISO 5211
Material : Aluminum Pressure Die Cast

IS / IEC 60079-1
CML-3812155
CIMFR
CE
CCEO Nagpur

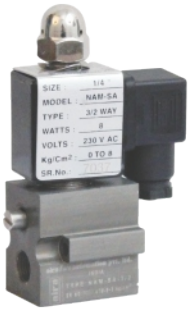

“aira” 3/2 Way Namur Direct Acting Solenoid Valve

Model	: NAM-SA-32
Coil Voltage	: All Std. Voltage Available
Frequency	: 50 - 60 Hz
Connection Type	: 1/4" (BSP / NPT)
Conduit	: PF 1/2"
Coil Insulation Grade	: Class "F"
Temperature	: -20 °C ~ 70 °C (-4 ~ 158 °F)
MOC	: Aluminium
Seals	: NBR (Viton On Request)
Working Pressure	: Upto 8 BAR

This 3/2 Namur is suitable for actuator model : 5412-S / ARA-49S / ARA-50S



“aira” 3/2 & 5/2 Way Convertible Poppet Type Single Namur Solenoid Valve

Model	: OTX - PPT - 32 / OTX - PPT - 52
Coil Voltage	: All Std. Voltage Available
Frequency	: 50 - 60 Hz
Connection Type	: 1/4" (BSP / NPT)
Conduit	: PF 1/2"
Coil Insulation Grade	: Class "F"
Temperature	: -20 °C ~ 70 °C (-4 ~ 158 °F)
MOC	: Aluminium
Seals	: NBR (Viton On Request)
Working Pressure	: Upto 8 BAR

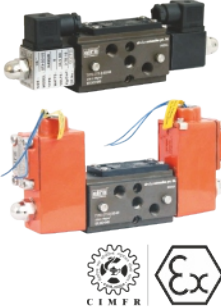

“aira” 3/2 & 5/2 Way Convertible Poppet Type Double Namur Solenoid Valve

Model	: 2OTX - PPT - 52
Coil Voltage	: All Std. Voltage Available
Frequency	: 50 - 60 Hz
Connection Type	: 1/4" (BSP / NPT)
Conduit	: PF 1/2"
Coil Insulation Grade	: Class "F"
Temperature	: -20 °C ~ 70 °C (-4 ~ 158 °F)
MOC	: Aluminium
Seals	: NBR (Viton On Request)
Working Pressure	: Upto 8 BAR



“aira” 3/2 & 5/2 Way Convertible Spool Type Single Namur Solenoid Valve

Model	: AMV-NAM-220
Coil Voltage	: All Std. Voltage Available
Frequency	: 50 - 60 Hz
Connection Type	: 1/4" (BSP / NPT)
Conduit	: PF 1/2"
Coil Insulation Grade	: Class "F"
Temperature	: -20 °C ~ 70 °C (-4 ~ 158 °F)
Body Material	: Aluminium
Seals	: NBR (Viton On Request)
Working Pressure	: Upto 8 BAR



“aira” 3/2 & 5/2 Way Convertible Spool Type Double Namur Solenoid Valve

Model	: 2AMV-NAM-220
Coil Voltage	: All Std. Voltage Available
Frequency	: 50 - 60 Hz
Connection Type	: 1/4" (BSP / NPT)
Conduit	: PF 1/2"
Coil Insulation Grade	: Class "F"
Temperature	: -20 °C ~ 70 °C (-4 ~ 158 °F)
Body Material	: Aluminium
Seals	: NBR (Viton On Request)
Working Pressure	: Upto 8 BAR



“aira” AJ Series 3/2 Way Direct Acting Solenoid Valve (Normally Open & Closed)

Model	: AIDS-09-202
Size	: 1/4" BSP
Body	: Aluminium Pressure Die Cast
Orifice	: 2 MM
Pressure	: 7 Kg/cm ² / 10 Kg/cm ²
Temp.	: Upto 50 °C
Leakage	: Bubble Tight
Frequency	: 50 ~ 60 Hz
Coil Insulation Grade	: Class "F"
Media	: Air (Filtered & Lubricated)
Voltage	: All Std. Voltage Available



“aira” Filter + Regulator Air Combination

Model	: 4FQ / 8 FQ / FRJ
Air Connection	: 1/4" BSP
Max. Supply Pressure	: 4FQ: 0.5 to 4 Kg/cm ² 8FQ: 0.5 to 8 Kg/cm ² 1 to 9 Kg/cm ²
Gauge Connection	: 1/8"
Ambient Temperature	: -20 °C ~ 120 °C (High Temp.) -40 °C ~ 120 °C (low Temp.)
Mini Filtering Size	: 5 Micron
Material	: Aluminium Pressure Die Cast

(4FQ / 8FQ) (FRJ)



“aira” Air Volume Booster

Model	: VLB
Size	: 1/4" to 1" BSP
MOC	: Aluminium / S. S. 304 / 316
Seals	: NBR
Max. Supply Pressure	: Max. 1Mpa (10 Bar)
Max. Output Pressure	: Max. 0.7 Mpa (7 Bar)
Temperature	: -20 °C ~ 70 °C (Standard) -20 °C ~ 120 °C (High) -40 °C ~ 70 °C (Low)
Linearity	: 1 : 1
Hysteresis	: 1%



“aira” Single & Double Air Lock Valve

Model	: SALV / DALV
Material	: Aluminum / Stainless Steel 304
Max. Supply Pressure	: Max. 10.2 Kg/cm ² (142 PSI)
Max. Single Pressure	: Max. 7.1 Kg/cm ² (1000 PSI)
Setting Pressure Range	: 1.4-7.1 Kg/cm ² (20 ~ 100 PSI)
Flow Capacity (Cv)	: 0.9
In/Output Port Connection	: 1/4" NPT
Signal Port Connection	: 1/4" NPT
Differential Pressure	: Below 0.1 Kg/cm ² (1.4 PSI)
Hysteresis	: 1%
ambient Temp.	: -20 °C ~ 70 °C

DALV SALV



“aira” Manual Override Clutch Type (MO)

Model	: AMO
Torque	: 200 Nm to 10000 Nm
Body	: Aluminium Pressure Die Cast / S. G. Iron
Lever Wheel	: Stainless Steel
Hand Wheel	: S. S. / M. S. (Fabricated)

Installations

- Indian Oil
- Reliance Industries Limited
- ONGC
- Hindalco
- Godrej
- Indian Railway
- Vedanta
- Voltas
- NTPC
- Gujarat State Fertilizers & Chemical Ltd.
- L & T
- Gail
- Hindustan Petroleum
- BHEL
- IFFCO
- BARC
- Thermax
- Essar

Application

- Process & Chemical
- Refineries & Petrochemicals
- Drugs & Pharmaceuticals
- Thermal Power Stations
- Dyes & Intermediates
- Breweries & Distilleries
- Steel Plants
- Onshore & Offshore Platforms
- Steel Plants
- Solvent Extraction Plants
- Sewage
- Cooling Water
- Ship Yards & Marine Management
- LPG Bottling Plants
- Water Works
- Pulp & Paper
- Fertilizers
- Textiles
- Sugar
- Nuclear & Atomic Power Stations
- Paints & Varnishes
- Soaps & Detergents
- Slurry & Ash handling
- Food & Oil Industry
- Effluent & Water Treatment

This Product is Generally made to use on the High Pressure Piping System, It is Widely Applied for Major Industrial Sectors

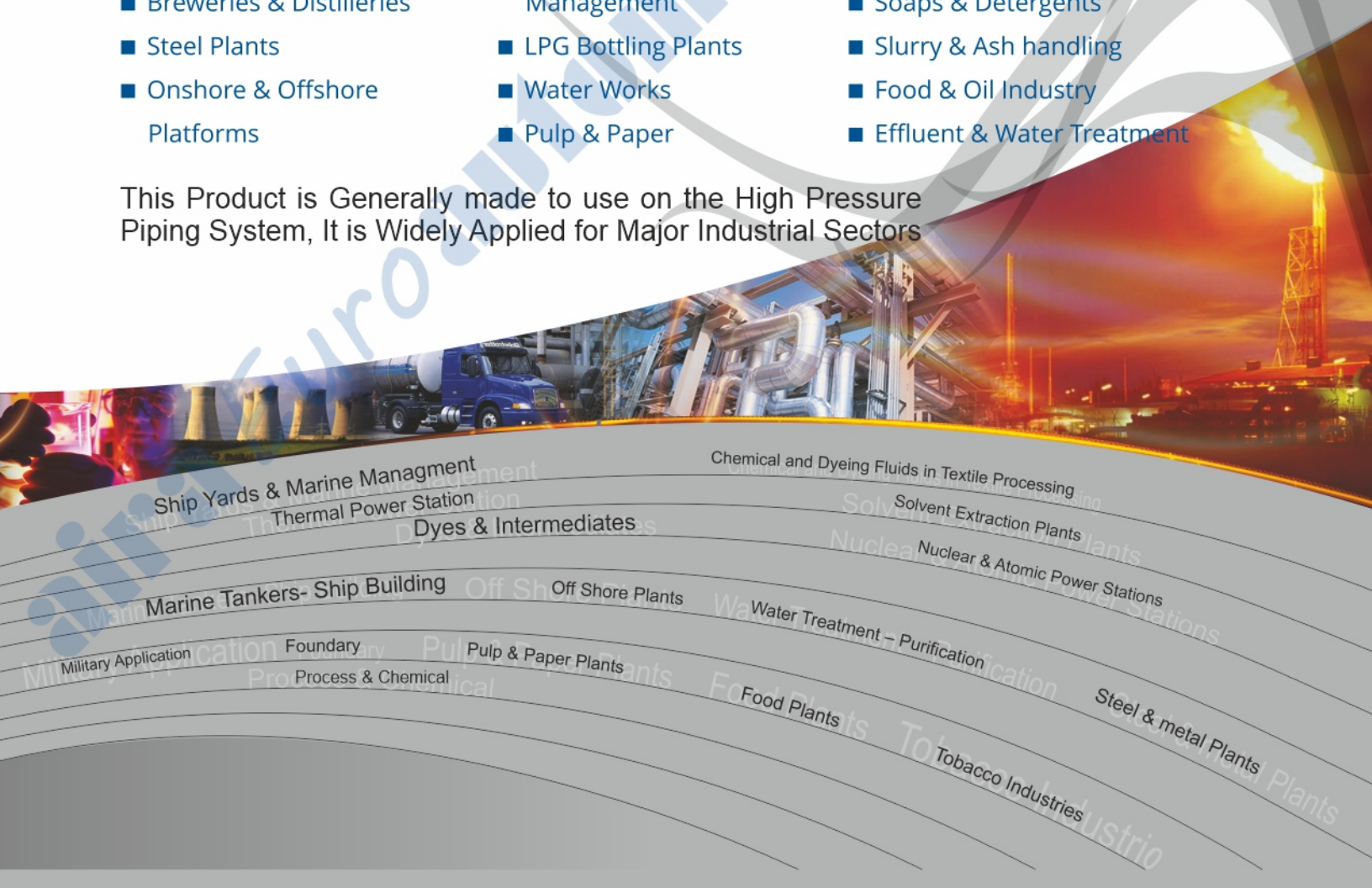

Ship Yards & Marine Management
Thermal Power Station

Dyes & Intermediates

Marine Tankers- Ship Building

Off Shore Plants

Military Application

Foundary

Pulp & Paper Plants

Process & Chemical

Water Treatment - Purification

Food Plants

Tobacco Industries

Steel & metal Plants

Chemical and Dyeing Fluids in Textile Processing

Solvent Extraction Plants

Nuclear & Atomic Power Stations

Nuclear & Atomic Power Stations



time tested designs with superior performance

GLOBAL

Network

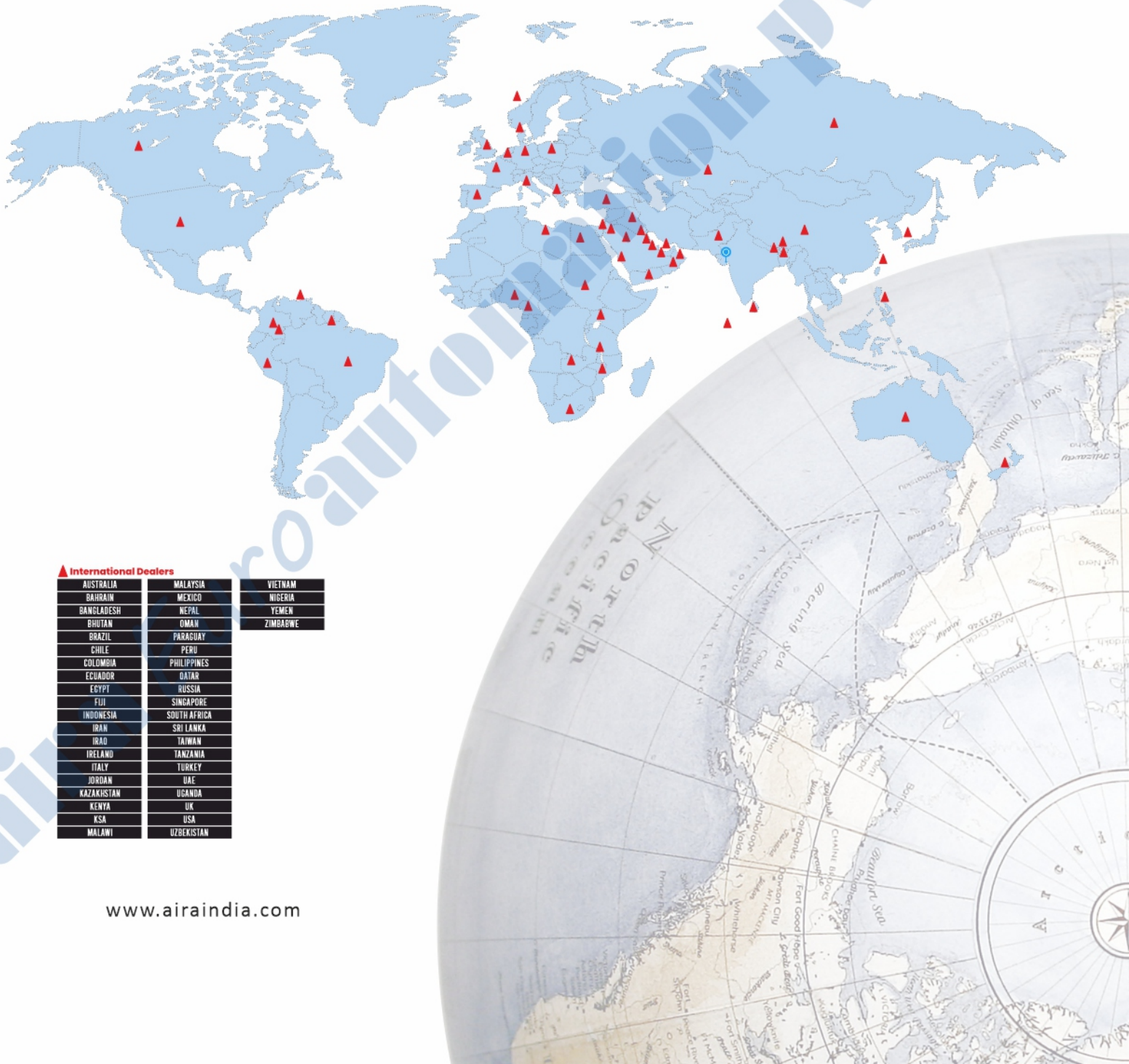

▲ International Dealers

AUSTRALIA	MALAYSIA	VIETNAM
BAHRAIN	MEXICO	NIGERIA
BANGLADESH	NEPAL	YEMEN
BHUTAN	OMAN	ZIMBABWE
BRAZIL	PARAGUAY	
CHILE	PERU	
COLOMBIA	PHILIPPINES	
ECUADOR	QATAR	
EGYPT	RUSSIA	
FUJI	SINGAPORE	
INDONESIA	SOUTH AFRICA	
IRAN	SRI LANKA	
IRAQ	TAIWAN	
IRELAND	TANZANIA	
ITALY	TURKEY	
JORDAN	UAE	
KAZAKHISTAN	UGANDA	
KENYA	UK	
KSA	USA	
MALAWI	UZBEKISTAN	



industrial valve automation

Network

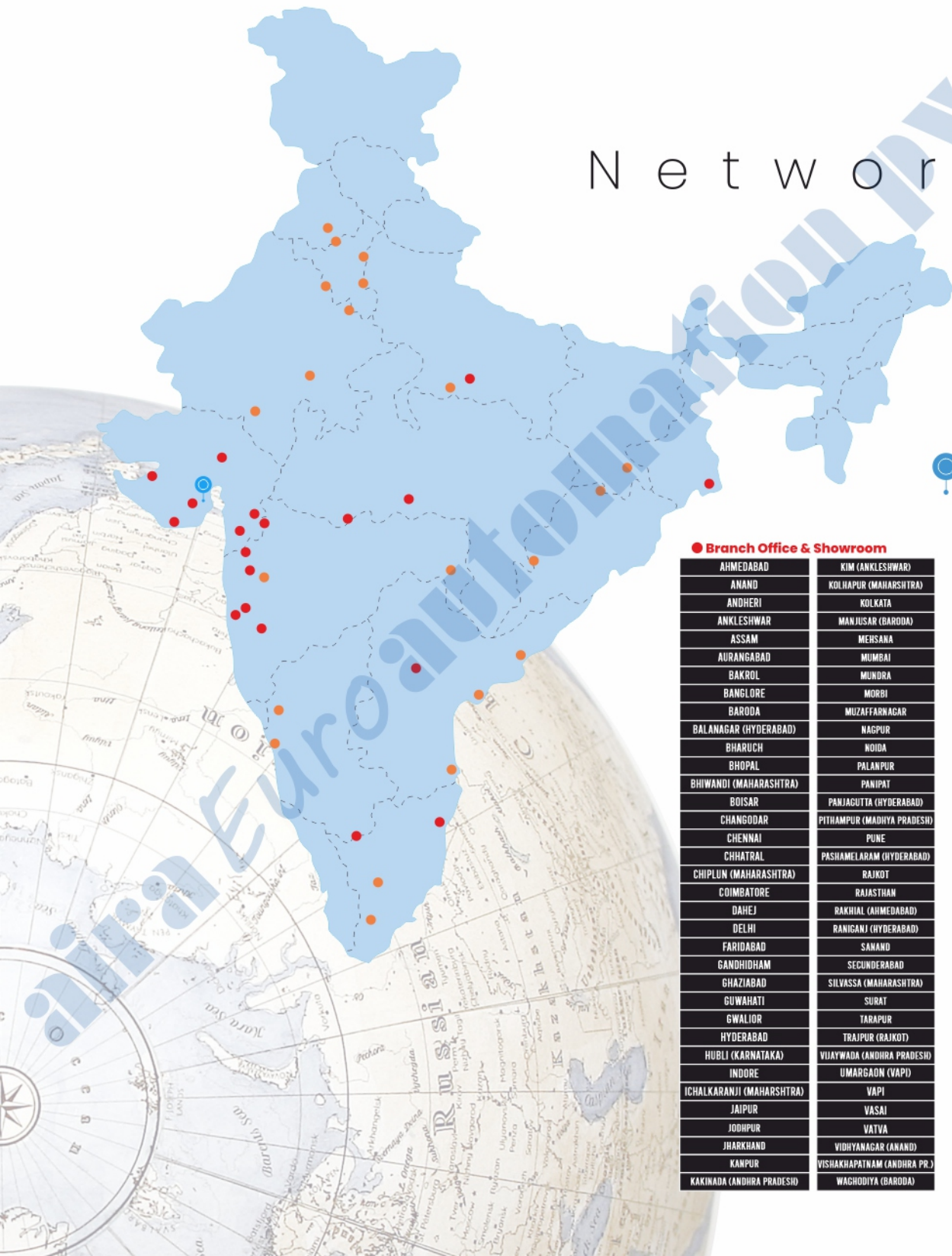

 Head Office & Works
AHMEDABAD

● Branch Office & Showroom

AHMEDABAD	KIM (ANKLESHWAR)
ANAND	KOLHAPUR (MAHARASHTRA)
ANDHERI	KOLKATA
ANKLESHWAR	MANJUSAR (BARODA)
ASSAM	MEHSANA
AURANGABAD	MUMBAI
BAKROL	MUNDRA
BANGLORE	MORBI
BARODA	MUZAFFARNAGAR
BALANAGAR (HYDERABAD)	NAGPUR
BHARUCH	NOIDA
BHOPAL	PALANPUR
BHIWANDI (MAHARASHTRA)	PANIPAT
BOISAR	PANJAGUTA (HYDERABAD)
CHANGODAR	PITHAMPUR (MADHYA PRADESH)
CHENNAI	PUNE
CHHATRAL	PASHAMELARAM (HYDERABAD)
CHIPLUN (MAHARASHTRA)	RAJKOT
COIMBATORE	RAJASTHAN
DAHEJ	RAKHIAL (AHMEDABAD)
DELHI	RANIGANJ (HYDERABAD)
FARIDABAD	SANAND
GANDHIDHAM	SECUNDERABAD
GHAZIABAD	SILVASSA (MAHARASHTRA)
GUWAHATI	SURAT
GWALIOR	TARAPUR
HYDERABAD	TRAJIPUR (RAJKOT)
HUBLI (KARNATAKA)	VIJAYWADA (ANDHRA PRADESH)
INDORE	UMARGAON (VAPI)
ICHALKARANJI (MAHARASHTRA)	VAPI
JAIPUR	VASAI
JODHPUR	VATVA
JHARKHAND	VIDHYANAGAR (ANAND)
KANPUR	VISHAKHAPATNAM (ANDHRA PR.)
KAKINADA (ANDHRA PRADESH)	WAGHODIYA (BARODA)

● Dealers & Distributors

AMRITSAR	KOLKATA
BALOTA	LUCKNOW
BANGLORE	LUDHIANA
BELGAUM	MARWAR
BHILWARA	MEERUT
CHANDICARH	MUZAFFARNAGAR
CHENNAI	NAGPUR
COCHIN	NOIDA
COIMBATORE	PANIPAT
DELHI	PEENYA
ERODE	PUNE
FARIDABAD	TRIPUR
GHAZIABAD	VARANASI
GOA	VISAKHAPATNAM
INDORE	WADI
JALANDHAR	KANPUR
JAMSHEDPUR	KOLHAPUR
JHARKHAND	

Mfg. & Mkt by :

aira Euroautomation pvt. ltd.
INDIA

Available At :