

Your Solution Partner In
Industrial Valve Automation...

PLUG VALVE

3 WAY PLUG VALVE FLANGED END



Mfg. & Mkt by :
aira Euroautomation pvt. ltd.
INDIA



About Us

Clients are why we exist!

We welcome and thank you for referring our detailed catalogue.

aira is known all over continents as a manufacturer of quality products - Ball Valves, Butterfly Valves, Plug Valves, & Control On / Off Valves with Pneumatic Actuators for Pharma, Oil & Gas, Steel, Paper, Water, Chemical and all type of processing industries.

aira has walked through more than 3 decades, gaining valuable experience, offering equipment's in the products manufactured by OEMs in all spheres of engineering. **aira** products have gained reputations of consultants, and approvals of users, OEMs and other as a quality product.

aira has expanding business into foreign markets specially GCC, UAE, Asian & African countries. This is because increase its customer base and revenue, leading to overall growth and success. Now foreign users come to know and believe in the services provided by the **aira**. Along with the same, it also helps to reach a large number of users thereby leading to the increase their business.

Being an ISO 9001 BVQI certified company has put **aira** in fore front. Our motto is "Value the customer" and "Superior product", one among the best in the world.

Our Quality

- In-House full scale testing facility.
- Lean manufacturing practices
- Certified by : ISO 9001 : 2015 (BVQI LONDON), CE, ATEX, CIMFR, BIS, PESO, SIL 3, IBR
- API 609, API 6D

Our Commitment

- To understand customer's need first before proposing our products.
- To keep on providing competitive rates by adapting to continuous process improvement, without compromising on quality.
- To provide continuous support to our customers and go beyond their expectations in terms of delivery and after sale services.

Our Manufacturing Facility

- In house R & D, manufacturing and testing facility is all located in a spread over three campuses at Ahmedabad, Gujarat, INDIA.

Network - Sales Office

- 60 Plus Branch Offices in different states in India.
- Sales office in the Bangladesh, Dubai, Kenya, Malaysia, Nepal, Qatar, Singapore, South Africa, Sri Lanka, Turkey, USA (Expanding).

QMS (Quality Management System)

ISO 9001 : 2015

EMS (Environment Management System)

ISO 14001 : 2015

OHSAS (Occupational Health & Safety Management System)

ISO 45001 : 2018

IBR
PISTON VALVE
GLOBE CONTROL VALVE (CKD/CND)
DISC CHECK VALVE (DCV)
PRESSURE REDUCING VALVE (PRV)
POP TYPE SAFETY VALVE
BALL VALVE

Pneumatic Actuator

CE /
ATEX /
EXIDA SIL-3 /
PROOF OF DESIGN

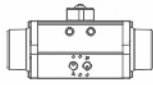

Scotch & Yoke Actuator

CE / ATEX / SIL-3

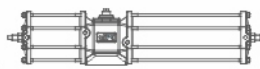

Stainless Steel Actuator

CE /
IEP ATEX



Positioner Enclosure

CE / CIMFR /
IP67 / BIS
/ PESO

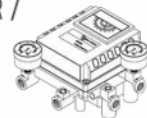

aira's
SOME OF OUR
Certificates

Plug Valve

FUGITIVE EMISSIONS
TEST
AS PER ISO
15848-1 / IBR

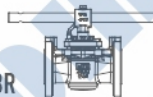

Flameproof Solenoid Valve

IEP ATEX / CE / CIMFR
/ IP65 / IP67 / IP68 /
BIS / PESO



Limit Switch

IEP ATEX / CE / CIMFR
/ IP67 / BIS / PESO /
EQDC IP68



Ball Valve (Floating & Trunnion)

FIRE SAFE TEST DESIGN /
FUGITIVE EMISSIONS TEST
AS PER ISO 15848-1 / CE /
PED / EXIDA SIL-3

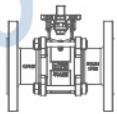

Butterfly Valve (centric / Double & Triple Eccentric)

FIRE SAFE TEST DESIGN /
FUGITIVE EMISSIONS TEST
AS PER ISO 15848-1 / CE /
PED / EXIDA SIL-3
IBR / PROOF OF DESIGN /
FOOD GRADE / BIS / ISI



Multiport Ball Valve

FUGITIVE EMISSIONS TEST
AS PER ISO 15848-1 / CE /
PED / EIL

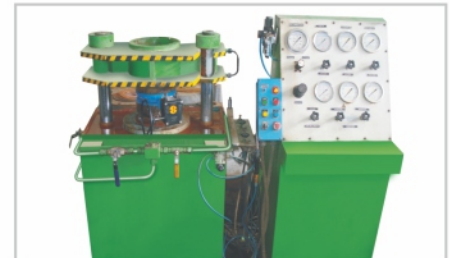
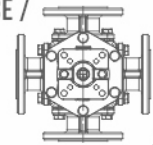

Warranty Information



Best In Class 4 - Year Warranty

Aira 'ARA' Actuator manufactured by Aira Euro Automation Pvt. Ltd. are warranted against defects in material or workmanship for a period of four years from date of shipment. Our sole obligation under this warranty is to repair or replace, at our option, any product Aira 'ARA' Actuator products manufactured by Aira Euro Automation Pvt. Ltd. are warranted against defects in material or workmanship for a period of four year from date of shipment. Our sole obligation under this warranty is to repair or replace, at our option, any product or any part or parts thereof found to be defective. Aira Euro Automation Pvt. Ltd. MAKES NO OTHER REPRESENTATION OR WARRANTY, EXPRESS OR IMPLIED, INCLUDING, BUT NOT LIMITED TO, ANY IMPLIED WARRANTY OF MERCHANTABILITY OR FITNESS FOR A PARTICULAR PURPOSE. The warranty set forth above is the only warranty applicable to Aira Euro Automation Pvt. Ltd. products and in no event shall Aira Euro Automation Pvt. Ltd. be liable for any delay, work stoppage, cartage, shipping, loss of use of equipment, loss of time, inconvenience, loss of profits of any direct or indirect incidental resulting from or attributable to a breach of warranty. The remedies under this warranty shall be the only remedies available. OUR MAXIMUM LIABILITY SHALL NOT IN ANY EVENT EXCEED THE CONTRACT PRICE FOR THE PRODUCT.

PRODUCT CODING 3 WAY PLUG VALVES

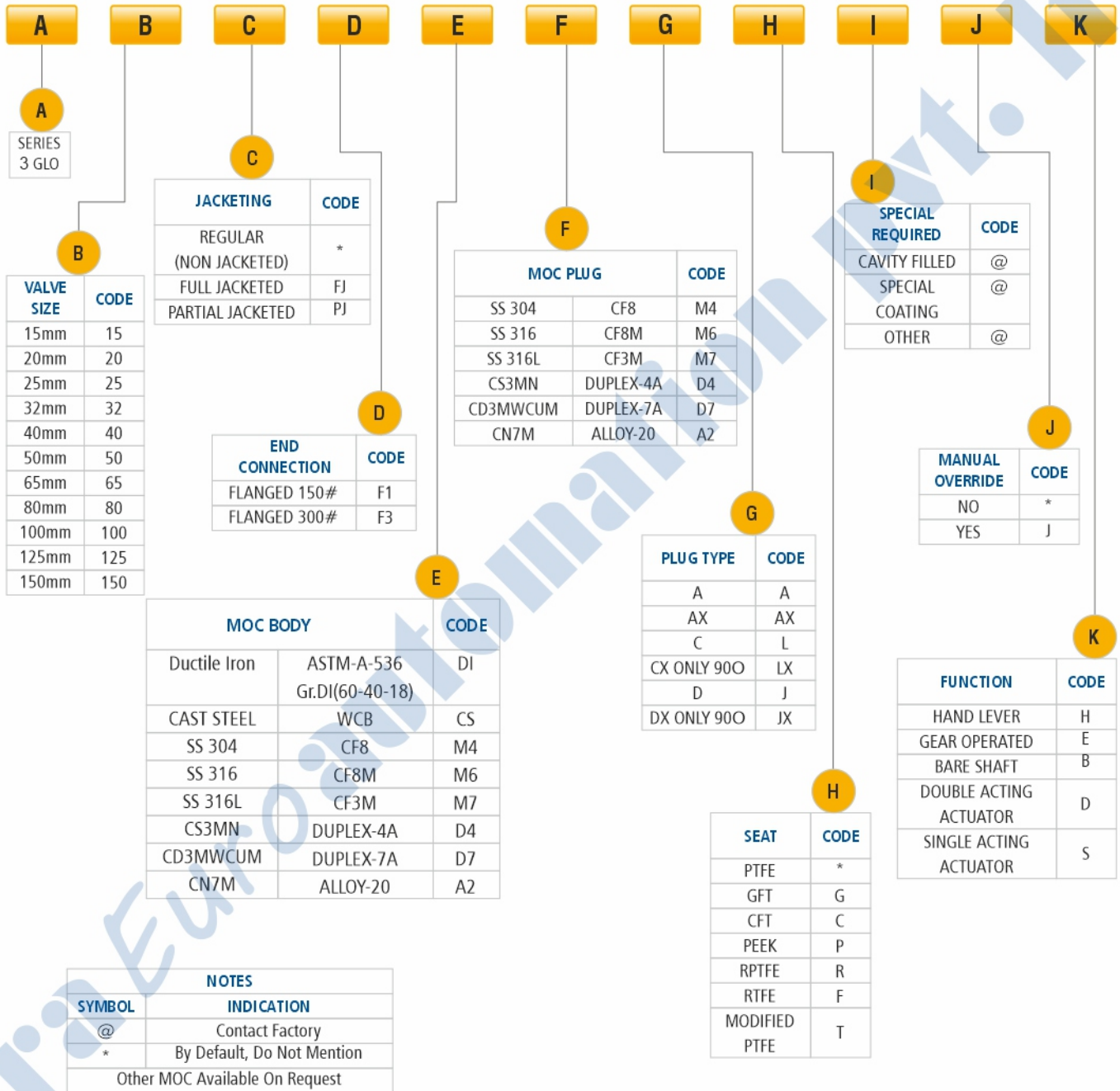

EXAMPLE-1	3GLO 15F1CSM4AGH	3GLO VALVE SIZE 15MM FLANGED 150# WCB BODY & CF8 "A" TYPE PLUG GFT SLEEVE HAND LEVER OPERATED
EXAMPLE-2	3GLO 150JF1M6M6E	3GLO VALVE SIZE 150MM JACKETED FLANGED 150# CF8M BODY & CF8M "C" TYPE PLUG PTFE SLEEVE GEAR OPERATED
EXAMPLE-3	3GLO 50F1CSM4JD	3GLO VALVE SIZE 50 50MM FLANGED 150# WCB BODY & CF8 "D" TYPE PLUG PTFE SLEEVE DOUBLE ACTING ACTUATOR OPERATED

Torque & Cv Value

Torque Values			
BREAK AWAY TORQUE NM			
Valve Size		150#	300#
MM	Inch		
15	1/2"	18	26
20	3/4"	18	38
25	1"	36	46
32	1.1/4"	46	52
40	1.1/2"	55	64
50	2"	114	135
65	2.1/2"	131	142
80	3"	162	175
100	4"	221	240
125	5"	295	325
150	6"	450	500
200	8"	750	805
250	10"	1400	1655
300	12"	1900	3500
350	14"	2500	
400	16"	5200	
450	18"	9000	
500	20"	13000	

ACTUATOR SELECTION MULTIPLY THE ABOVE VALUES BY THE FOLLOWING FACTORS (F) TO GET THE ACTUATOR TORQUE.

SERVICE	FACTOR 'F'
RAW WATER	1.35
WET SERVICE	1.35
STEAM	1.25
GAS	1.40
SLURRY	1.80
VISCOUS LIQUID	2.00

Notes :

- For GFT, CFT, GRFT & SS Filled PTFE Seats
Multiply The Above Values By 1.2
- For Torque of lined valves please contact marketing person.

Pressure Test Chart

Test Pressure & Duration As Per API 598						
Pressure Rating	Hydro Test Pressure		Valve Size	Test Duration In Seconds		
	Body (Kg/cm ²)	Seat (Kg/cm ²)		Body (Minutes-Seconds)	Seat (Minutes-Seconds)	Back Seat (Minutes-Seconds)
150#	30	22	2" & Smaller	0.25 - 15	0.25 - 15	0.25 - 15
300#	80	58	2.1/2" to 6"	1 - 60	1 - 60	1 - 60
600#	155	115	8" to 12"	2 - 120	2 - 120	1 - 60
800#	211	151	14" & Larger	5 - 300	2 - 120	1 - 60
900#	233	170				
1500#	393	286				
2500#	653	478				

Pneumatic (Air) Testing Only For Seat 7 Kg/cm²

Test Pressure & Duration As Per BS EN 12266-1						
Pressure Rating	Body (Kg/cm ²)	Seat (Kg/cm ²)	Valve Size	Test Duration In Seconds		
				Body (Minutes-Seconds)	Seat (Minutes-Seconds)	
PN 10	15	11				
PN 16	24	18				
PN 25	40	28	2" & Smaller	0.25 - 15	0.25 - 15	
PN 40	60	45	2.1/2" to 6"	1 - 60	1 - 60	
			8" to 12"	2 - 120	2 - 120	
PN 64	100	71	14" & Larger	5 - 30	2 - 120	

Flow Co - Efficients		
Valve Size		Plug Valve Cv
MM	Inch	
15	1/2"	9
20	3/4"	14
25	1"	44
32	1.1/4"	66
40	1.1/2"	92
50	2"	175
65	2.1/2"	245
80	3"	290
100	4"	545
125	5"	650
150	6"	1070
200	8"	1580
250	10"	2165
300	12"	3159
350	14"	3300
400	16"	6400
450	18"	6500
500	20"	9200

Flow Coefficient (Cv) is a basic industry wide standard which is defined as "The rate of flow of water in US gallon's per minute that will generate a pressure drop of one pound per square inch across the valve".

$$Cv = \frac{Q}{\sqrt{\frac{\Delta P}{SG}}}$$

WHERE,

- Q** = FLOW RATE IN US gal / min
- SG** = SPECIFIC GRAVITY OF LIQUID (WATER = 1)
- ΔP** = PRESSURE DROP ACROSS THE VALVE, PSI
- Ky** = Cv / 1.17

Hydraulic Testing



Plug Valve Features

General

"aira" Non lubricated Sleeved & Lined Plug Valve are designed in accordance with API 599 for ANSI Class Ratings 150 & 300. Nominal sizes from 1/2" to 16" Valves Have been design for use with various combinations of material Such as : Carbon Steel, Low Carbon Steel, Special Alloy, Stainless Steel, Monel, Inconel. 2 Way and Multiport Plug Valves are available for variety of applications.

Unmatched Superior Sealing. Bi-directional Zero leakage.

Primary sealing by PTFE sleeve with high pressure ribs for In-line sealing. Second by wedge ring. Independent Tertiary sealing by diaphragm. Leaving absolutely no chance for atmospheric leakage.

This gives highest level of sealing when compared to any other valve design. (When compared with conventional ball valve, butterfly valve, gate valve, globe valve designs)

Inherently Cavity Free.

No dead space. No fluid accumulation. No contamination. No sticking of media on plug.

360° port lips.

360° port lips provide a self-cleaning action to remove scaling and adhering media. PTFE even through high grade plastic which is vulnerable to cold flow (permanent deformation) when subjected to varying loads and temperature. In a plug valve the 360° port acts along with upper and lower boundary restrict the sleeve preventing cold flow.

Less Joints. Less Problems.

Single piece body, tapered plug, cover. Improved monolithic compact design ensures lower costs and better performance.

No maintenance.

In case of PTFE sleeve wear from usage, a slight turn of adjusting bolt presses the plug down regaining sealing pressure making valve as good as new. No lubrication is needed even after long period of inactivity, thanks to low co-efficient of friction of PTFE sleeves and smooth finished surface of plug. And even in case of regular maintenance plug valves are top entry valves, hence, need not be removed from the line and can be easily serviced.

Construction & Working

Basic structure is plug, sleeve, body. Sleeve is inserted inside the body. Tapered plug is inserted into the sleeve. The sleeve acting as a soft seat completely surrounds plug creating areal sealing surfaces. Also not permitting any dead space in the flow path. Plug is rotating 90 degree. When it is aligned with the body port, flow is open. When the plug is rotated so that plug port is perpendicular to the body port the flow is blocked. The media kept in the plug while at closed position, will be contained in the plug port only, and when the valve is open again, the flow will flush the media out.

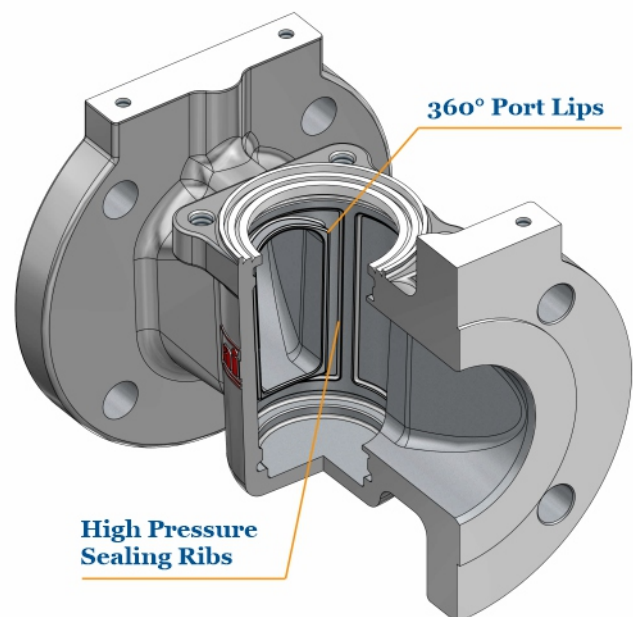
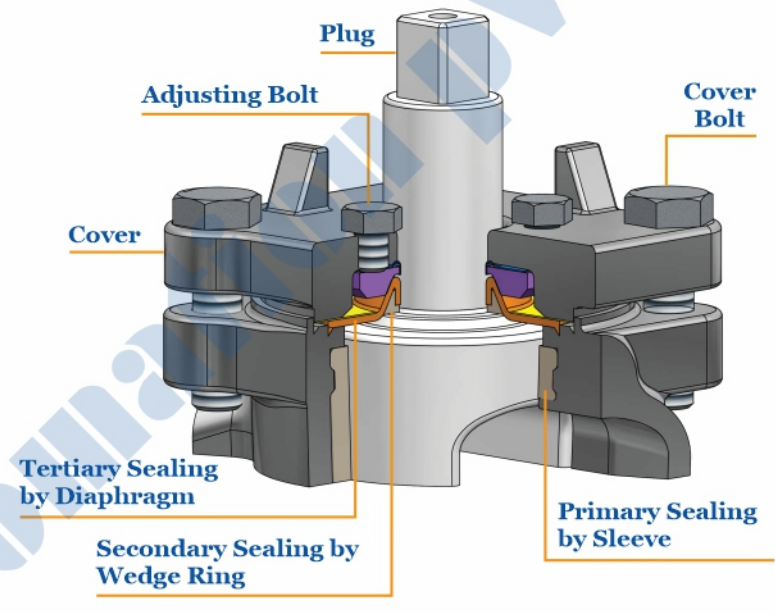

Plug Valve Exploded View

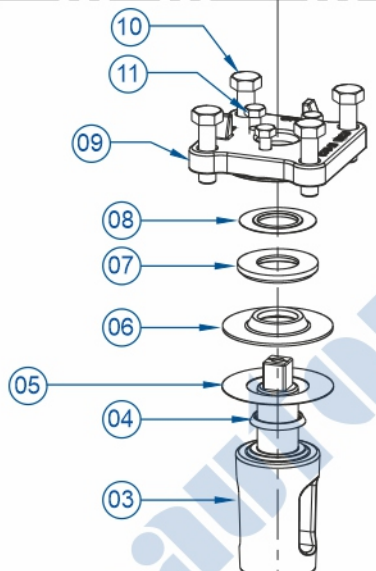
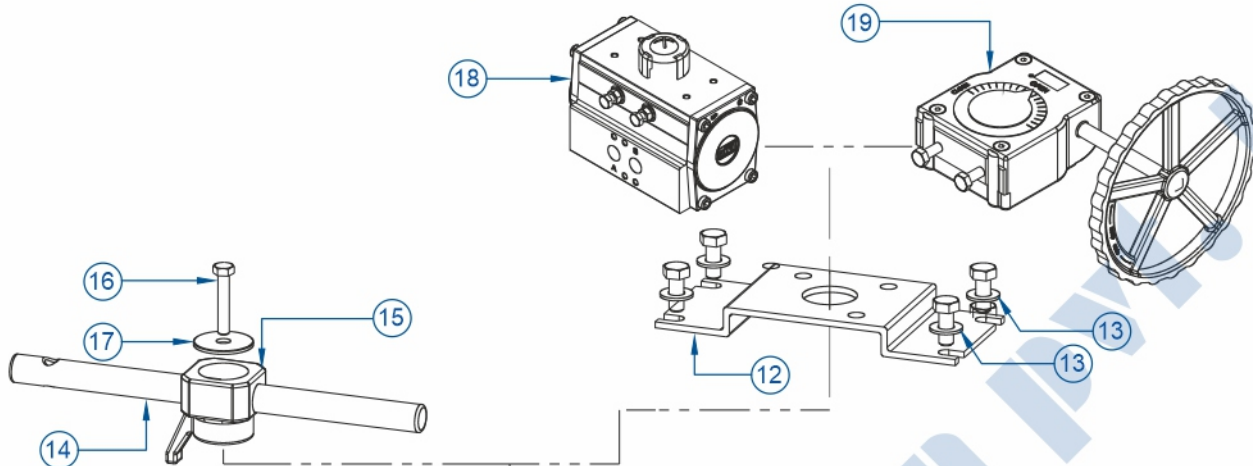

Sr. No.	Description	Material
01	Body	Ductile Iron / WCB / CF8 / CF8M / CF3M
02	Sleeve	PTFE / CFT / GFT
03	Plug	CF8 / CF8M / CF3M
04	PTFE Wedge Ring	PTFE / CFT / GFT
05	Metal Diaphragm	S. S. 304
06	PTFE Diaphragm	PTFE / CFT / GFT
07	Thrust Collar	S. S. 304
08	Static Eliminator	S. S. 304
09	Cover	WCB / CF8 / CF8M / CF3M
10	Hex Bolt (Cover to Body)	S. S. 304
11	Plug Adjusting Bolt	S. S. 304
12	Bracket	S. S. 304 / S. S. 316
13	Act. Bracket Fitting Bolt + Washer	S. S. 304
14	Handle	S. S. 302
15	Coupler	S. S. 304
16	Hex Bolt	S. S. 304
17	Washer	S. S. 304
18	Actuator	STD.
19	Gear Box	STD.

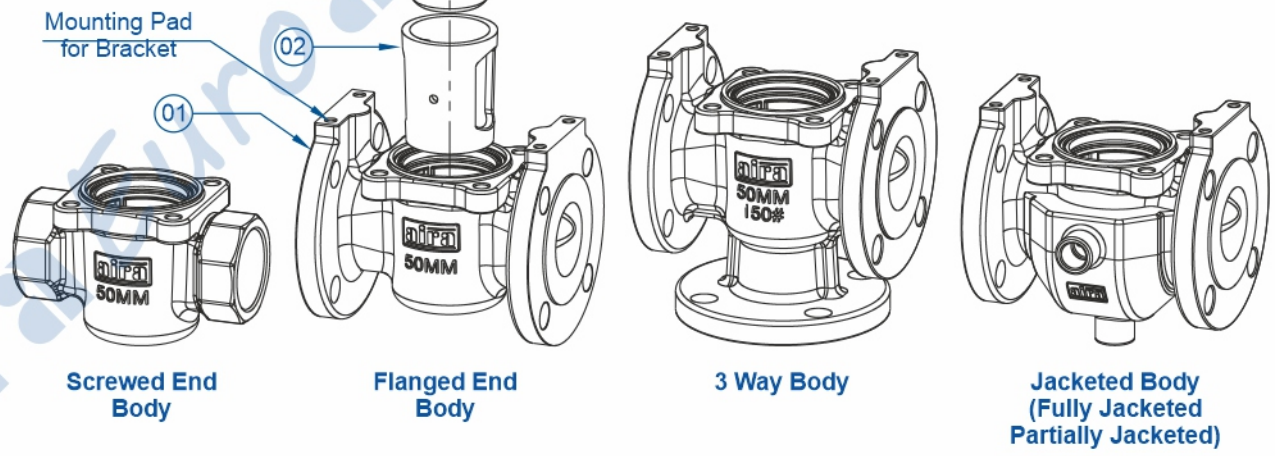

“aira” 3 Way Plug Valve Flanged End 150#

aira Plug valves are designed to offer superior performance in various industrial applications. Design inherent reduction in pressure drop leads to higher efficiency and better flow rates. Long service life, unmatched sealing capacity and ease of maintenance thanks to ingenious design make the **aira** plug valves a preferred choice in severe service conditions.

Size Range : 1/2" to 6" (15 MM to 150 MM)

Standard

Design And Mfg. Std. : API 599 / BS 5353
 Valve Face To Face Dimension : As Per Mfg Std.
 Inspection & Testing : API 598 / EN 12266 - 1
 Leakage Class : CLASS VI ISO - 5208



“FIRE SAFE VALVES ARE AVAILABLE ON REQUEST”

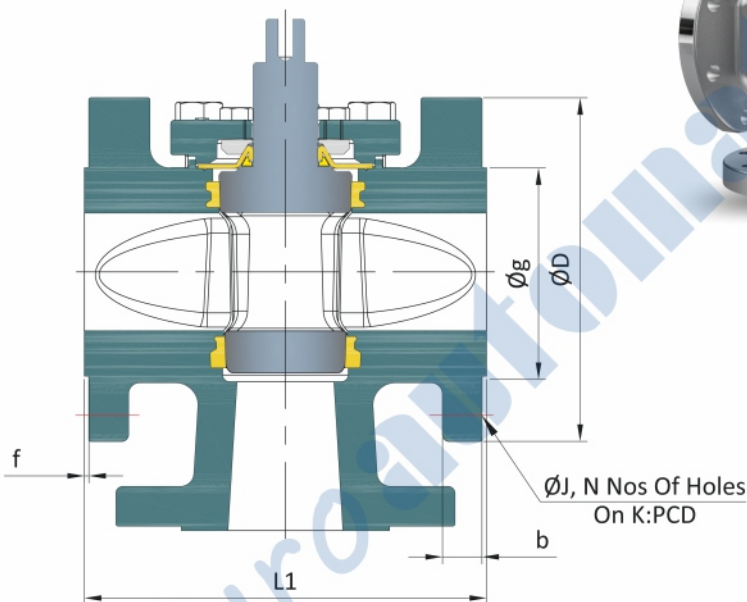

Accessories

- On / Off Indicator
- Namur Standard Solenoid Valve in all standard Coil Voltage Flameproof Coil Available
- Pneumatic - Pneumatic Valve Positioner
- Electro - Pneumatic Valve Positioner
- Smart Positioner
- Manual Over Ride
- Limit Switch for On / Off Indication at panel board
- Filter + Regulator Combination with Pressure gauge
- Air Lock Valve











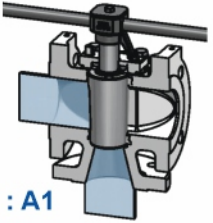
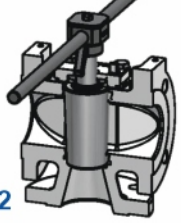
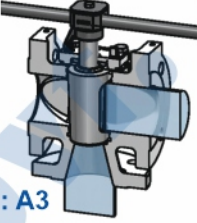

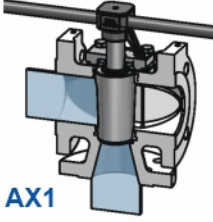
150# Dimensions :

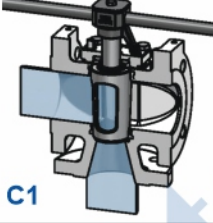
Valve Size		L1	ØD	Øg	b	f	ØJ	N	PCD	Weight Approx. Kgs
MM	Inch									
15	1/2"	108	90	34.9	9.6	2	15.88	4	60.3	2.630
20	3/4"	117	100	42.9	11.2	2	15.88	4	69.9	3.150
25	1"	127	110	50.8	12.7	2	15.88	4	79	5.150
32	1.1/4"	140	115	63.5	14.5	2	15.88	4	88.9	5.900
40	1.1/2"	165	124.87	73	15.93	2	15.88	4	98.4	8.400
50	2"	178	150	92.1	17.5	2	19.05	4	120.7	13.700
65	2.1/2"	190	180	104.8	20.7	2	19.05	4	139.7	19.200
80	3"	203	190	127	22.3	2	19.05	4	152.4	21.500
100	4"	229	230.5	157.2	23.34	2	19.05	8	190.5	33.350
150	6"	267	280	215.9	25	2	22.23	8	241.17	60.800

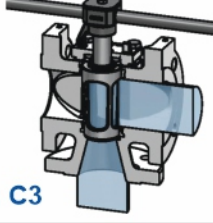
(All Dimensions are in mm & Weight are for bare shaft only)

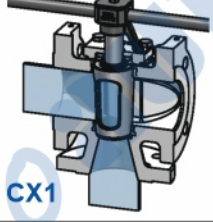
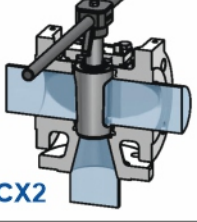
Multiport Valves

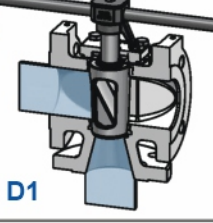
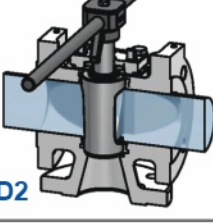
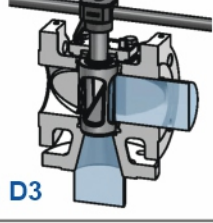
The versatility of 3GLO multiport valves and the variety of flow arrangements in which they are available make these valves ideal for many types of piping systems handling liquids, gases, slurries or other applications where tight shut - off is required.

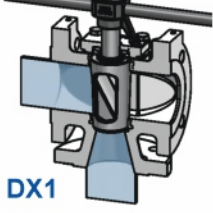
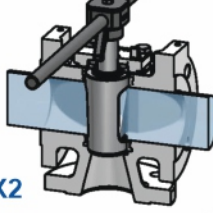
Type	0° Position	90° Position	180° Position
A 	 Code : A1	 Code : A2	 Code : A3
AX 	 Code : AX1	 Code : AX2	
C 	 Code : C1	 Code : C2	 Code : C3
CX Only 90° 	 Code : CX1	 Code : CX2	
D 	 Code : D1	 Code : D2	 Code : D3
DX Only 90° 	 Code : DX1	 Code : DX2	

Pneumatic Rotary Actuator Accessories

Pneumatic - Pneumatic & Electro Pneumatic ROTARY Valve Positioner



Electro - Pneumatic
Model
AEP-1000-R

Input Signal : 4 ~ 20 mA DC
Supply Air Pressure : 20 ~ 100 psi Max.
(7.0 Kg/cm²)
Standard Stroke : 10 ~ 80 mm
Air Pipe Connection : 1/4" NPT
Ambient Temperature : -20 °C to 70 °C
Degree of Protection : IP 65
Out-put Characteristics : Rotary
Conduit Connection : 1/2" NPT
Body Material : Aluminium Die Cast



Pneumatic - Pneumatic
Model
APP-1200-RDN



Pneumatic - Pneumatic & Electro Pneumatic LINEAR Valve Positioner



Electro - Pneumatic
Model
AEP-1000-LSN

Input Signal : 3 ~ 15 (0.2 ~ 1.0 Kg/cm²)
Supply Air Pressure : 100 psi Max.
(7.0 Kg/cm²)
Standard Stroke : 10 ~ 80 mm
Air Pipe Connection : 1/4" NPT
Ambient Temperature : -20 °C to 70 °C
Degree of Protection : IP 65
Out-put Characteristics : Linear
Conduit Connection : 1/2" NPT
Body Material : Aluminium Die Cast



Pneumatic - Pneumatic
Model
APP-1200-LSN



SMART Positioner LINEAR



Model : IP 6000 Series
Body : Aluminium
Set Point Signal : 4 - 20mA DC
Ambient Temperature : Normal Version : -20 °C ~ 70 °C
Optional Version : -40 °C ~ 70 °C
Supply Pressure : 0.14 - 0.7 MPa
Flow : 55L/min (Sup=0.14MPa)



Weatherproof MICRO Limit Switch Box



Model : MMLS-BX-WP-01-A
MMLS-BX-WP-01-B
MMLS-BX-WP-01-C
Switch : Honeywell ZM / NJ2-V3-N /
NBB-V3-Z4
Type : 1 NO + 1 NC / 2 Switch
Enclosure Protection : IP 67
Ambient Temperature : -20 °C to 80 °C
Conduit Entry : 1/2" - NPT
Terminal : 8 Point
Mounting Bracket : Namur VDI / VDE3845 / ISO 5211
Material : Aluminium Die Cast



Flameproof Limit Switch Box



Model : MLS-BX-FLP-01-A
MLS-BX-FLP-01-B
MLS-BX-FLP-01-C
MLS-BX-FLP-01-D
Switch : Honeywell V15 / Honeywell
V 15 PCB Type / NCB2-V3-NO /
NJ2-V3-N / NBB-V3-Z4 / NBB3-V3-Z4
: 1 NO + 1 NC / 2 NO + 2 NC / 2 Switch
Type : IP 68
Enclosure Protection : IP 68
Ambient Temp. : -20 °C to 80 °C
Conduit Entry : 1/2" - NPT
Terminal : 8 Point
Mounting Bracket : Namur VDI / VDE3845 / ISO 5211
Material : Aluminium Die Cast



Flameproof Limit Switch Box STAINLESS STEEL 304 / 316



Model : LS4-BX-FLP-01-A / LS6-BX-FLP-01-A
LS4-BX-FLP-01-B / LS6-BX-FLP-01-B
LS4-BX-FLP-01-C / LS6-BX-FLP-01-C
LS4-BX-FLP-01-D / LS6-BX-FLP-01-D
Switch : Honeywell V15 / Honeywell
V 15 PCB Type / NCB2-V3-NO /
NJ2-V3-N / NBB-V3-Z4 / NBB3-V3-Z4
: 1 NO + 1 NC / 2 NO + 2 NC / 2 Switch
Type : IP 67
Enclosure Protection : IP 67
Ambient Temp. : -20 °C to 80 °C
Conduit Entry : 1/2" - NPT
Terminal : 8 Point
Mounting Bracket : Namur VDI / VDE3845 / ISO 5211
Material : ASTM A351 Gr. CF8 / CF8M / CF3M



Weatherproof Limit Switch Box (Big Box)



Model : MLS4-BX-01-A / MLS4-BX-01-B
MLS4-BX-01-C / MLS4-BX-01-D
Switch : Honeywell V 15 / NJ2-V3-N /
NBB-V3-Z4 / NCB2-V3-NO
Type : 1 NO + 1 NC / 2 NO + 2 NC /
2 Switch
Enclosure Protection : IP 67
Ambient Temperature : -20 °C to 80 °C
Conduit Entry : 1/2" - NPT
Terminal : 8 Point
Mounting Bracket : Namur VDI / VDE3845 /
ISO 5211
Material : Aluminium Die Cast



Weatherproof Limit Switch Box STAINLESS STEEL 304 / 316



Model : MLS4-BX-01-A / MLS4-BX-01-B
MLS4-BX-01-C / MLS4-BX-01-D
Switch : Honeywell V 15 / NJ2-V3-N /
NBB-V3-Z4 / NCB2-V3-NO
Type : 1 NO + 1 NC / 2 NO + 2 NC /
2 Switch
Enclosure Protection : IP 67
Ambient Temperature : -20 °C to 80 °C
Conduit Entry : 1/2" - NPT
Terminal : 8 Point
Mounting Bracket : Namur VDI / VDE3845 /
ISO 5211
Material : ASTM A351 Gr. CF8 / CF8M / CF3M



Pneumatic Rotary Actuator Accessories

3/2 Way Namur Direct Acting Solenoid Valve



Model	: NAM-SA-32
Coil Voltage	: All Std. Voltage Available
Frequency	: 50 - 60 Hz
Connection Type	: 1/4" (NPT)
Conduit	: PF 1/2"
Coil Insulation Grade	: Class "F"
Ambient Temp.	: -20 °C ~ 70 °C
MOC	: Aluminium
Seals	: NBR (Viton On Request)
Working Pressure	: Upto 0 to 10 Kg/cm ²

5/2 Way Convertible Poppet Type SINGLE & DOUBLE Namur Solenoid Valve



Model	: OTX-ALU-52 / 2OTX-ALU-52
Coil Voltage	: All Std. Voltage Available
Frequency	: 50 - 60 Hz
Connection Type	: 1/4" (NPT)
Conduit	: PF 1/2"
Coil Insulation Grade	: Class "F"
Ambient Temp.	: -20 °C ~ 70 °C
MOC	: Aluminium
Seals	: NBR (Viton On Request)
Working Pressure	: Upto 2.5 to 10 Kg/cm ²

3/2 Way Internal Pilot Operated STAINLESS STEEL 316 Single Namur Solenoid Valve



Model	: MPT-S6-32
Coil Voltage	: All Std. Voltage Available
Frequency	: 50 - 60 Hz
Connection Type	: 1/4" (NPT)
Conduit	: PF 1/2"
Coil Insulation Grade	: Class "F" & "H"
Ambient Temp.	: -20 °C ~ 70 °C
MOC	: ASTM A351 Gr. CF8M
Seals	: NBR (Viton On Request)
Working Pressure	: Upto 2.5 to 10 Kg/cm ²

5/2 Way Poppet Type STAINLESS STEEL 316 Single Namur Solenoid Valve



Model	: OTX-S6-52
Coil Voltage	: All Std. Voltage Available
Frequency	: 50 - 60 Hz
Connection Type	: 1/4" (NPT)
Conduit	: PF 1/2"
Coil Insulation Grade	: Class "F" & "H"
Ambient Temp.	: -20 °C ~ 70 °C
MOC	: ASTM A351 Gr. CF8M
Seals	: NBR (Viton On Request)
Working Pressure	: Upto 2.5 to 10 Kg/cm ²

3/2 Way Midget Type Direct Acting Solenoid Valve



Model	: DMV
Size	: 1/4"
Body	: CF8 / CF8M / Brass / S.S 304
Orific	: 2
Pressure	: 7 Kg / cm ²
Temp.	: Upto -5 to 80 °C max.
Coil Rating	: Continuous Rated
Coil Insulation	: "F" Class & "H" Class For Flameproof
Media	: Air & Gas
Voltage	: 12V, 24V, 48V, 110V, 230V, AC/DC

3/2 Way Midget Type Direct Acting Solenoid Valve



Model	: MDV
Size	: 1/4"
Body	: CF8 / CF8M / Brass / S.S 304
Orific	: 2
Pressure	: 7 Kg / cm ²
Temp.	: Upto -5 to 80 °C max.
Coil Rating	: Continuous Rated
Coil Insulation	: "F" Class & "H" Class For Flameproof
Media	: Air & Gas
Voltage	: 12V, 24V, 48V, 110V, 230V, AC/DC

Filter + Regulator Air Combination



Model	: 4FQ / 8 FQ / FRJ / AFRS4
Air Connection	: 1/4"
Max. Supply Pressure	: 4FQ : 0.5 to 4 Kg / cm ² 8FQ : 0.5 to 8 Kg / cm ² FRJ : 1 to 9 Kg / cm ²
Gauge Connection	: 1/8"
Ambient Temp.	: -20 °C ~ 70 °C
Mini Filtering Size	: 5 Micron
Material	: Aluminium Pressure Die Cast / CF8 / CF8M

Air Volume Booster



Model	: VLB
Size	: 1/4" to 1"
MOC	: Aluminium
Seals	: NBR
Supply Pressure	: 10 Bar
Output Pressure	: 7 Bar
Temperature	: -20 °C ~ 70 °C

Single & Double Air Lock Valve



Model Single	: SALV
Model Double	: DALV
Size	: 1/4" to 3/4"
MOC	: Aluminium
Seals	: NBR
Supply Pressure	: 10 Bar
Output Pressure	: 7 Bar
Temperature	: -20 °C ~ 70 °C

Manual Override Clutch Type (MO)



Model	: AMO
Torque	: 200 Nm to 10000 Nm
Body	: Aluminium Pressure Die Cast / S. G. Iron
Lever Wheel	: Stainless Steel
Hand Wheel	: S.S. / M.S. (Fabricated)



time tested designs with superior performance

GLOBAL

Network

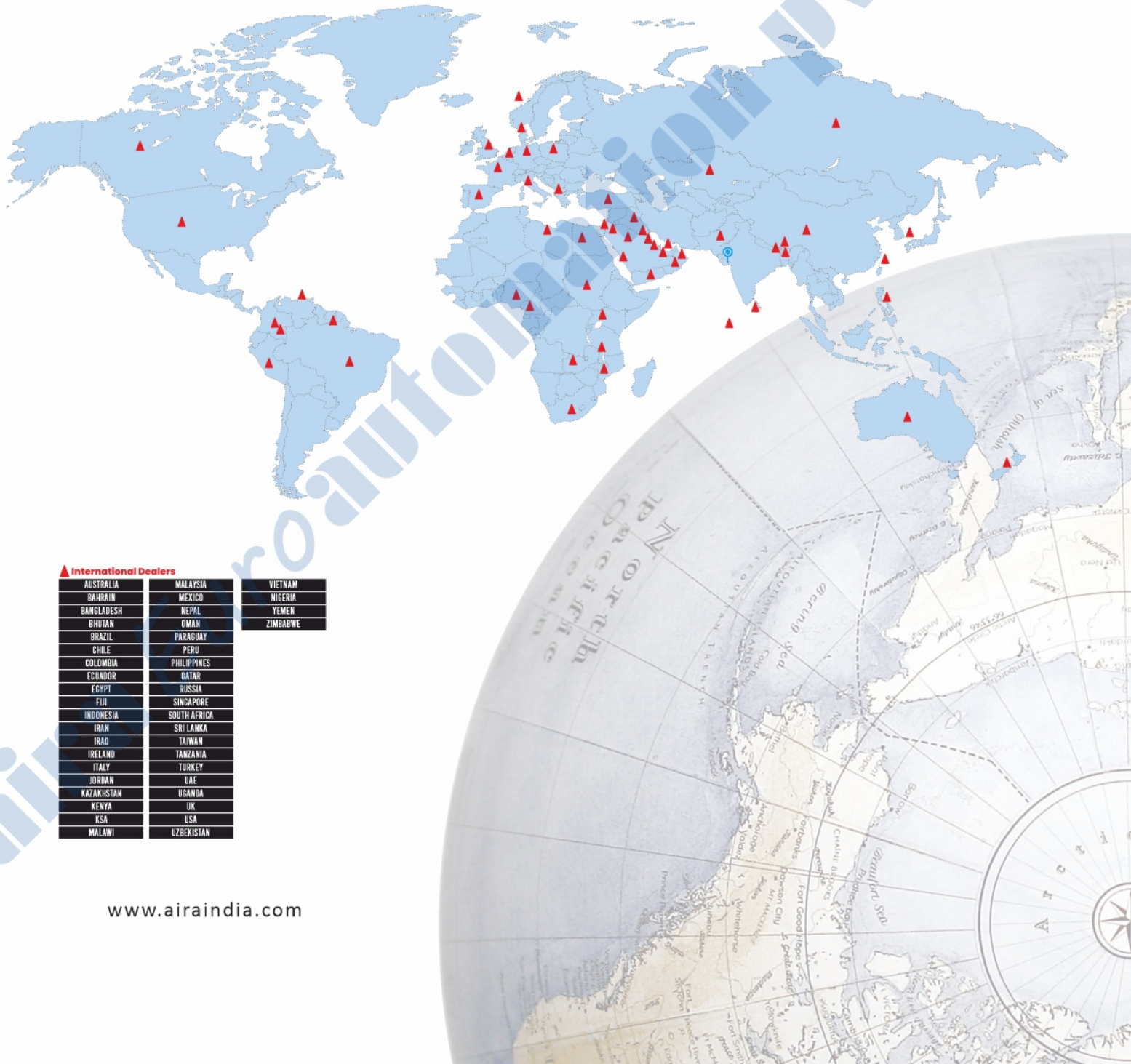

▲ International Dealers

AUSTRALIA	MALAYSIA	VIETNAM
BAHRAIN	MEXICO	NIGERIA
BANGLADESH	NEPAL	YEMEN
BHUTAN	OMAN	ZIMBABWE
BRAZIL	PARAGUAY	
CHILE	PERU	
COLOMBIA	PHILIPPINES	
ECUADOR	QATAR	
EGYPT	RUSSIA	
FUJI	SINGAPORE	
INDONESIA	SOUTH AFRICA	
IRAN	SRI LANKA	
IRAQ	TAIWAN	
IRELAND	TANZANIA	
ITALY	TURKEY	
JORDAN	UAE	
KAZAKHISTAN	UGANDA	
KENYA	UK	
KSA	USA	
MALAWI	UZBEKISTAN	



industrial valve automation

Network

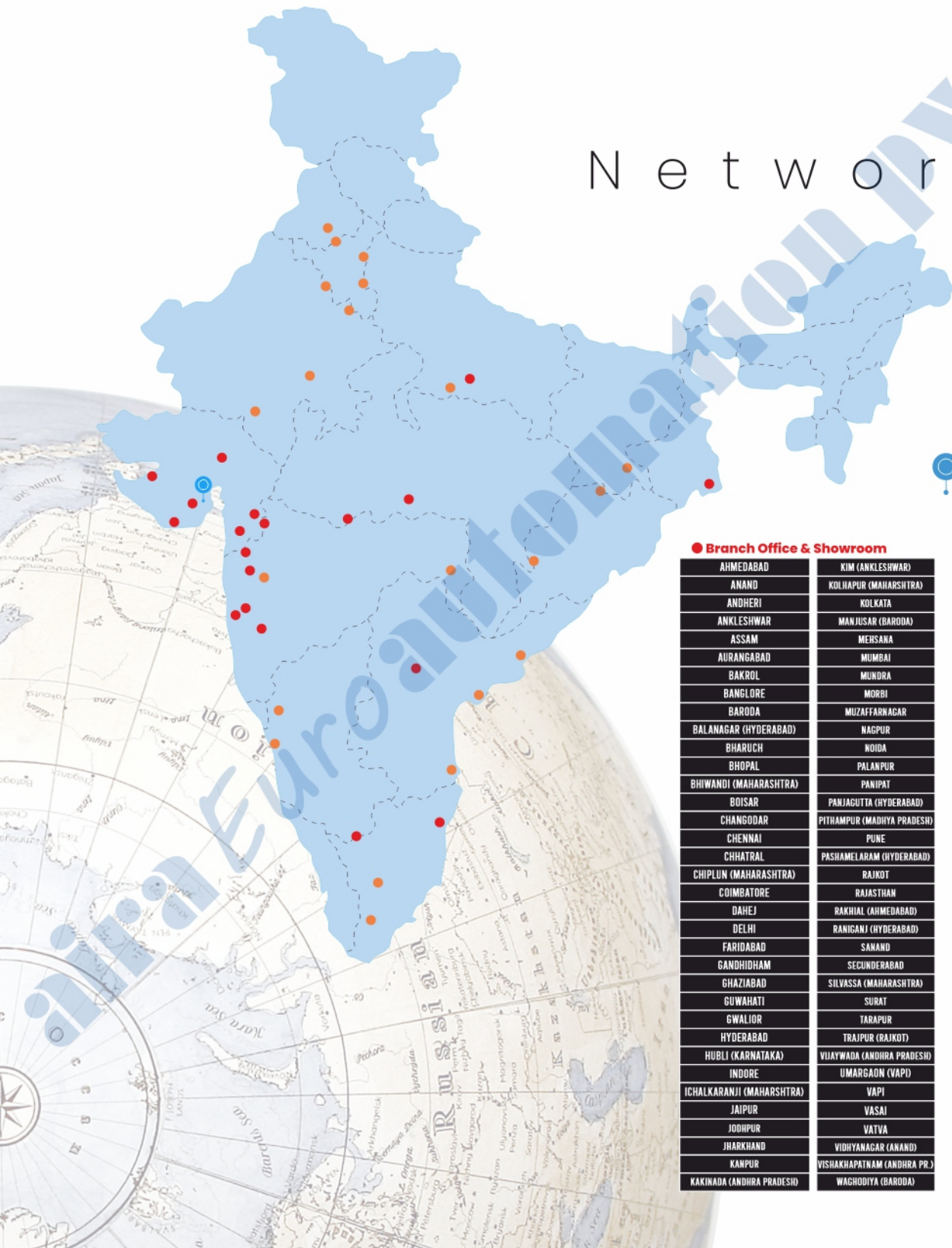

● Head Office & Works
AHMEDABAD

● Branch Office & Showroom

AHMEDABAD	KIM (ANKLESHWAR)
ANAND	KOLHAPUR (MAHARASHTRA)
ANDHERI	KOLKATA
ANKLESHWAR	MANJUSAR (BARODA)
ASSAM	MEHSANA
AURANGABAD	MUMBAI
BAKROL	MUNDRA
BANGLORE	MORBI
BARODA	MUZAFFARNAGAR
BALANAGAR (HYDERABAD)	NAGPUR
BHARUCH	NOIDA
BHOPAL	PALANPUR
BHIWANDI (MAHARASHTRA)	PANIPAT
BOISAR	PANJAGUTA (HYDERABAD)
CHANGODAR	PITHAMPUR (MADHYA PRADESH)
CHENNAI	PUNE
CHHATRAL	PASHAMELARAM (HYDERABAD)
CHIPLUN (MAHARASHTRA)	RAJKOT
COIMBATORE	RAJASTHAN
DAHEJ	RAKHIAL (AHMEDABAD)
DELHI	RANIGANJ (HYDERABAD)
FARIDABAD	SANAND
GANDHIDHAM	SECUNDERABAD
GHAZIABAD	SILVASSA (MAHARASHTRA)
GUWAHATI	SURAT
GWALIOR	TARAPUR
HYDERABAD	TRAJIPUR (RAJKOT)
HUBLI (KARNATAKA)	VIJAYWADA (ANDHRA PRADESH)
INDORE	UMARGAON (VAPI)
ICHALKARANJI (MAHARASHTRA)	VAPI
JAIPUR	VASAI
JODHPUR	VATVA
JHARKHAND	VIDHYANAGAR (ANAND)
KANPUR	VISHAKHAPATNAM (ANDHRA PR.)
KAKINADA (ANDHRA PRADESH)	WAGHODIYA (BARODA)

● Dealers & Distributors

AMRITSAR	KOLKATA
BALOTA	LUCKNOW
BANGLORE	LUDHIANA
BELGAUM	MARWAR
BHILWARA	MEERUT
CHANDICARH	MUZAFFARNAGAR
CHENNAI	NAGPUR
COCHIN	NOIDA
COIMBATORE	PANIPAT
DELHI	PEENYA
ERODE	PUNE
FARIDABAD	TRIPUR
GHAZIABAD	VARANASI
GOA	VISAKHAPATNAM
INDORE	WADI
JALANDHAR	KANPUR
JAMSHEDPUR	KOLHAPUR
JHARKHAND	

Mfg. & Mkt by :
aira Euroautomation pvt. ltd.
INDIA

Available At :

