

Your Solution Partner in
Industrial Valve
Automation...



Solenoid Valve



2/2 & 3/2 Way Solenoid Valve

- High Pressure & High Temperature
- Screwed / Flanged / T. C. End
- Voltage : 12V, 24V, 48V, 110V, 230V, AC/DC
- Coil Type : General / IP 65 & 67 / IS / IEC 60529
- Flame Proof / Weather Proof / Terminal Junction Box
- Intrinsically Safe Coil



Mfg. & Mkt by :

airaEuroautomation pvt. ltd.
INDIA



IBR

CE



www.airaindia.com



About Us

Clients are why we exist!

We welcome and thank you for referring out detailed catalogue.

aira is know all over continents as a manufacturer of quality products - Ball Valves, Butterfly Valves, Plug Valves, & Control On / Off Valves with Pneumatic Actuators for Pharma, Oil & Gas, Steel, Paper, Water, Chemical and all type of processing industries.

aira has walked through more than 3 decades, gaining valuable experience, offering equipment's in the products manufactured by OEMs in all spheres of engineering. **aira** products have gained reputations of consultants, and approvals of users, OEMs and other as a quality product.

aira has expanding business into foreign markets specially GCC, UAE, Asian & African countries. This is because increase its customer base and revenue, leading to overall growth and success. Now foreign users come to know and believe in the services provided by the **aira**. Along with the same, it also helps to reach a large number of users thereby leading to the increase their business.

Being and ISO 9001 BVQI certified company has put **aira** in fore front. Out motto is "Value the customer" and "Superior product", one among the best in the world.

Our Quality

- In- House full scale testing facility.
- Lean manufacturing practices
- Certified by : ISO 9001 : 2015 (BVQI LONDON), CE, ATEX, CIMFR, BIS, PESO, SIL 3, IBR
- API 609, API 6D

Our Commitment

- To understand customer's need first before proposing our products.
- To keep on providing competitive rate's by adapting to continuous process improvement, without compromising on quality.
- To provide continuous support to our customers and go beyond their expectations in terms of delivery and after sale services.

Our Manufacturing Facility

- In house R & D, manufacturing and testing facility is all located in a spread over three campuses at Ahmedabad, Gujarat, INDIA.

Network - Sales Office

- 60 Plus Branch Offices in different states in India.
- Sales office in the Bangladesh, Dubai, Kenya, Malaysia, Nepal, Qatar, Singapore, South Africa, Sri Lanka, Turkey, USA (Expanding).

www.airaindia.com



QMS (Quality Management System)

ISO 9001 : 2015

EMS (Environment Management System)

ISO 14001 : 2015

OHSAS (Occupational Health & Safety Management System)

ISO 45001 : 2018

IBR
PISTON VALVE
GLOBE CONTROL VALVE (CKD/CND)
DISC CHECK VALVE (DCV)
PRESSURE REDUCING VALVE (PRV)
POP TYPE SAFETY VALVE
BALL VALVE

Pneumatic Actuator

CE /
ATEX /
EXIDA SIL-3 /
PROOF OF DESIGN

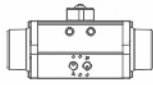

Scotch & Yoke Actuator

CE / ATEX / SIL-3

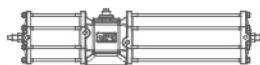

Stainless Steel Actuator

CE /
IEP ATEX

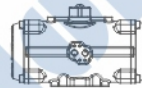

Positioner Enclosure

CE / CIMFR /
IP67 / BIS
/ PESO

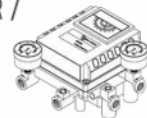

aira's
SOME OF OUR
Certificates

Plug Valve

FUGITIVE EMISSIONS
TEST
AS PER ISO
15848-1 / IBR



Flameproof Solenoid Valve

IEP ATEX / CE / CIMFR
/ IP65 / IP67 / IP68 /
BIS / PESO

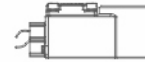

Limit Switch

IEP ATEX / CE / CIMFR
/ IP67 / BIS / PESO /
EQDC IP68



Ball Valve (Floating & Trunnion)

FIRE SAFE TEST DESIGN /
FUGITIVE EMISSIONS TEST
AS PER ISO 15848-1 / CE /
PED / EXIDA SIL-3

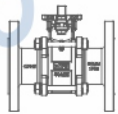

Butterfly Valve (centric / Double & Triple Eccentric)

FIRE SAFE TEST DESIGN /
FUGITIVE EMISSIONS TEST
AS PER ISO 15848-1 / CE /
PED / EXIDA SIL-3
IBR / PROOF OF DESIGN /
FOOD GRADE / BIS / ISI



Multiport Ball Valve

FUGITIVE EMISSIONS TEST
AS PER ISO 15848-1 / CE /
PED / EIL

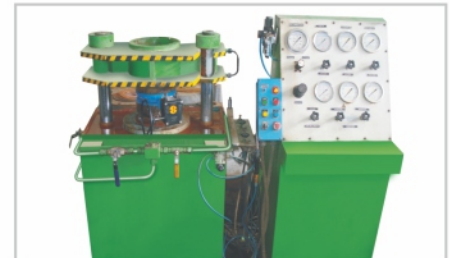
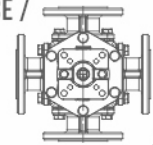

Company Profile

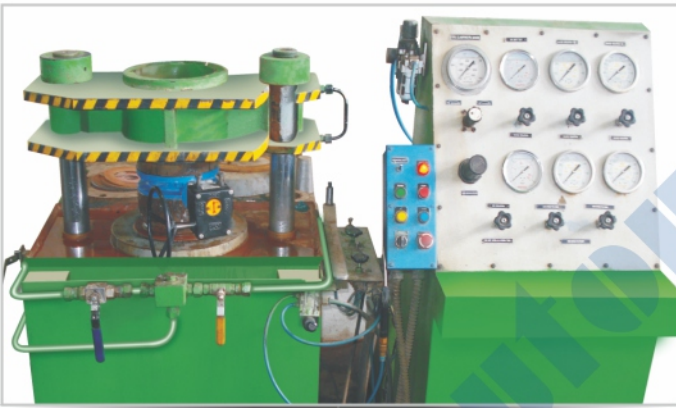

www.airaindia.com



2/2 Way Semi Lift Diaphragm Operated Solenoid Valve



"aira" Offers 2/2 Way Semi Pilot, high performance diaphragm type solenoid valve, for high volume and low pressure application in Air, Gas, Water, Vacuum, Light oil, Corrosive Fluids available in normally closed & normally open design.

Size Range : 1/2" to 2" Screwed / Flanged / Triclover End

Valves Specification	
Pressure	0 to 2 Bar
Temperature	Upto 85 OC (High Temperature On Request)
Coil Voltage	12V, 24V, 48V, 110V, 230V, AC/DC
Coil Insulation	"F" Class / "H" Class for Flameproof
Coil Encloser	IP 67 (Flame Proof / Explosion Proof as Per IS / Meets IEC 60079-1 STD for Class II A, II B, II C Zone
Coil Rating	Continuous Rated
Ends	S/E, F/E 150# / TC End
Media	Air, Gas, Water, Light Oil, Vacuum & Corrosive

Caution

- Suitable for Dry Steam
- Hot water temperature limited up to 180 OC only
- Avoid Back Pressure
- INSTALLATION OF "FILTER" IN INLET SIDE IS HIGHLY RECOMMENDED



Model : SSG

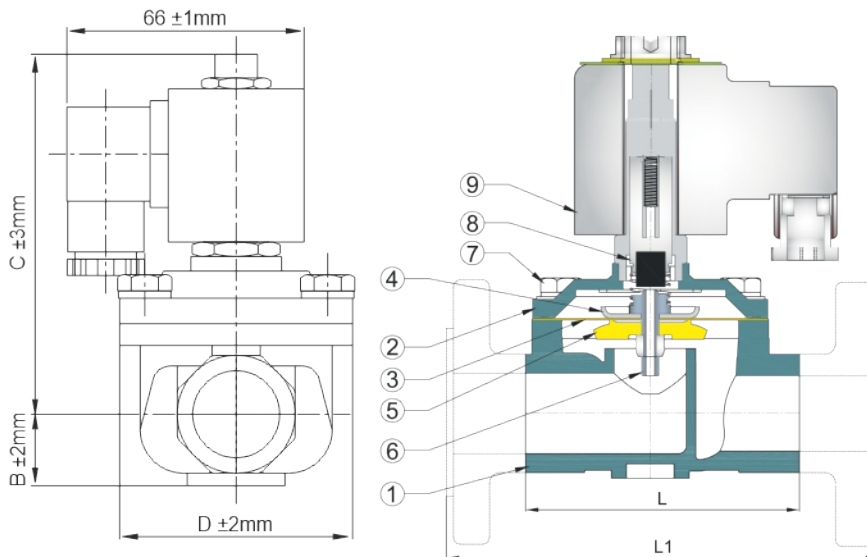

Solenoid Coil



(For General)
2200 Model with Adaptor



(For General)
2210 Model With Wire Type



Explosion & Flame Proof Coil
[As per IS / IEC 60079-1 standard approved by Central Institute of Mining and Fuel Research (CIMFR)]

Sr. No.	Description	Description
1	Body	CF8 / CF8M / CF3M
2	Cover	CF8 / CF8M / CF3M
3	Diaphragm	NBR
4	Embossed Washer	S. S. 304
5	Diaphragm Seat	NBR
6	Pilot Pin + Nut	S. S. 304
7	Hex Bolt + Washer	S. S.
8	Housing Set	STD.
9	Solenoid Coil	STD.

Dimensions :

Valve Model	Valve Size		L S / E	L1 F / E	B	C	D	Weight Approx.	
	MM	Inch						S / E	F / E
SSG - 15	15	1/2"	65	130	14	99.5	57	0.700	1.500
SSG - 20	20	3/4"	80	150	20.0	102.5	68.0	1.000	2.100
SSG - 25	25	1"	97	160	26.5	110	82.0	1.400	2.900
SSG - 40	40	1.1/2"	118	200	34.0	124	112.5	2.150	4.950
SSG - 50	50	2"	137	230	38.0	136	120	3.000	7.350

Note : Flange Dimensions as per 150#.

(All Dimensions are in mm)

www.airaindia.com

Installations

- Indian Oil
- Reliance Industries Limited
- ONGC
- Hindalco
- Godrej
- Indian Railway
- Vedanta
- Voltas
- NTPC
- Gujarat State Fertilizers & Chemical Ltd.
- L & T
- Gail
- Hindustan Petroleum
- BHEL
- IFFCO
- BARC
- Thermax
- Essar

Applications

- Air
- Water
- Gas
- Light Oil
- Light Chemical
- High Volume & Low Pressure Application
- Vacuum
- Corrosive Fluids
- Autoclaves
- Gas Burning Equipments
- Pump Seal Water Application
- Low Pressure Water Circulation System
- Solar Heating System
- Gas Generator
- Hot Water
- Steam
- High Temperature Fluids
- LD Oil
- Chemical
- Dust Collector Application
- Ceramic Filters
- Drain & Dispensing
- Oil Centrifuge Plants
- Low Pressure Oil

This Product is Generally made to use on the High Pressure Piping System, It is Widely Applied for Major Industrial Sectors

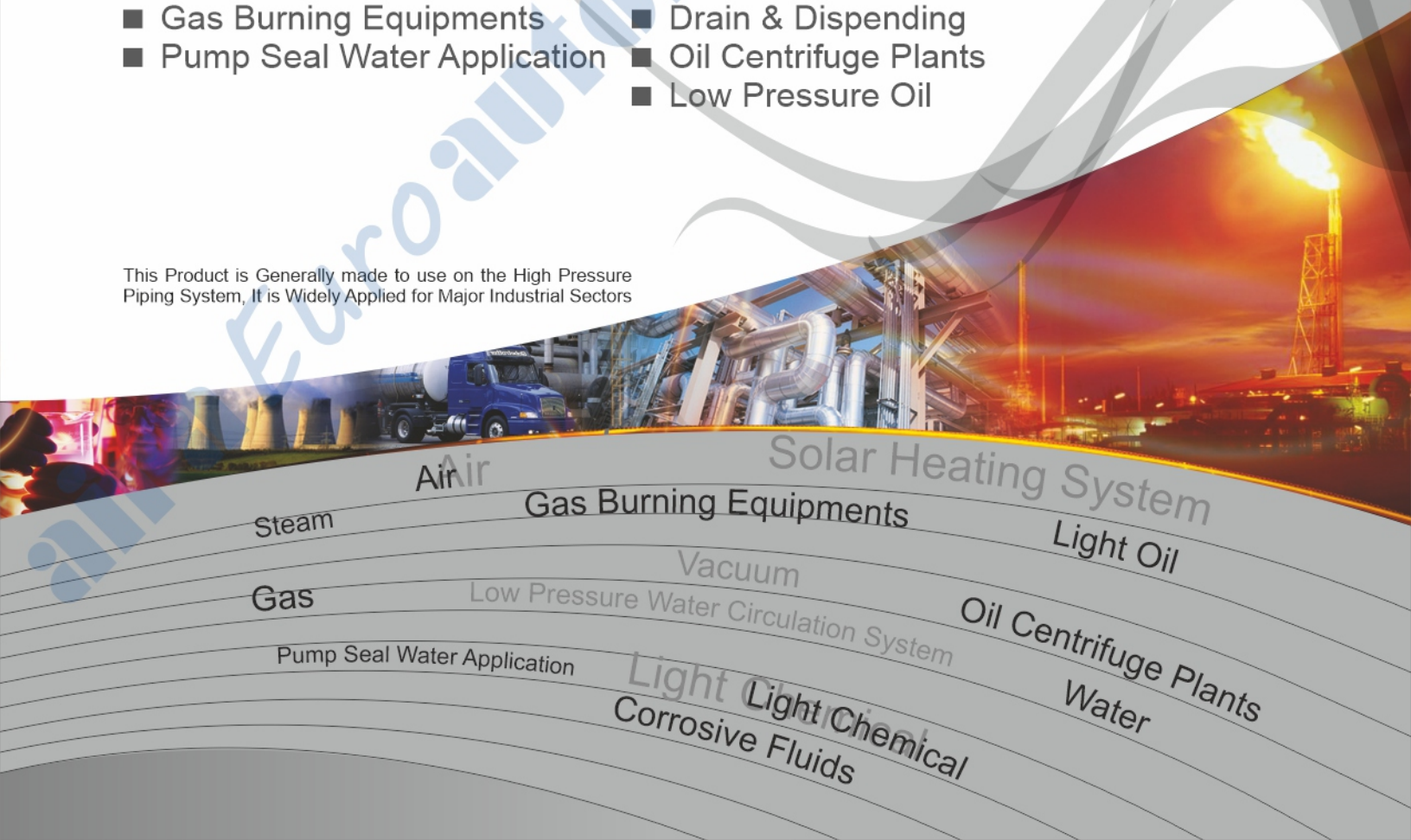

Air
 Steam
 Gas
 Pump Seal Water Application
 Solar Heating System
 Gas Burning Equipments
 Vacuum
 Low Pressure Water Circulation System
 Light Chemical
 Corrosive Fluids
 Light Oil
 Oil Centrifuge Plants
 Water



time tested designs with superior performance

GLOBAL

Network

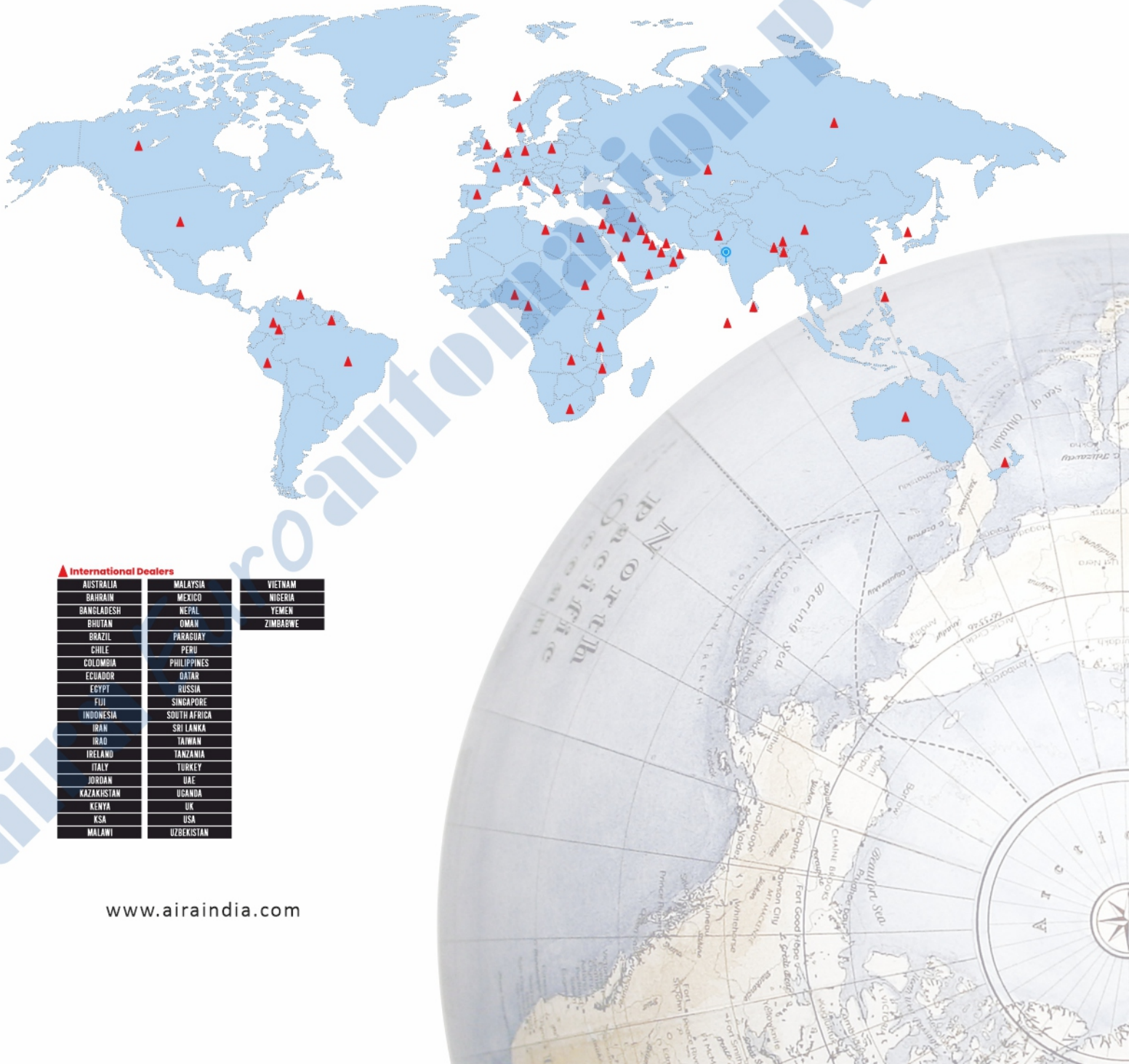

▲ International Dealers

AUSTRALIA	MALAYSIA	VIETNAM
BAHRAIN	MEXICO	NIGERIA
BANGLADESH	NEPAL	YEMEN
BHUTAN	OMAN	ZIMBABWE
BRAZIL	PARAGUAY	
CHILE	PERU	
COLOMBIA	PHILIPPINES	
ECUADOR	QATAR	
EGYPT	RUSSIA	
FUJI	SINGAPORE	
INDONESIA	SOUTH AFRICA	
IRAN	SRI LANKA	
IRAQ	TAIWAN	
IRELAND	TANZANIA	
ITALY	TURKEY	
JORDAN	UAE	
KAZAKHISTAN	UGANDA	
KENYA	UK	
KSA	USA	
MALAWI	UZBEKISTAN	



industrial valve automation

Network

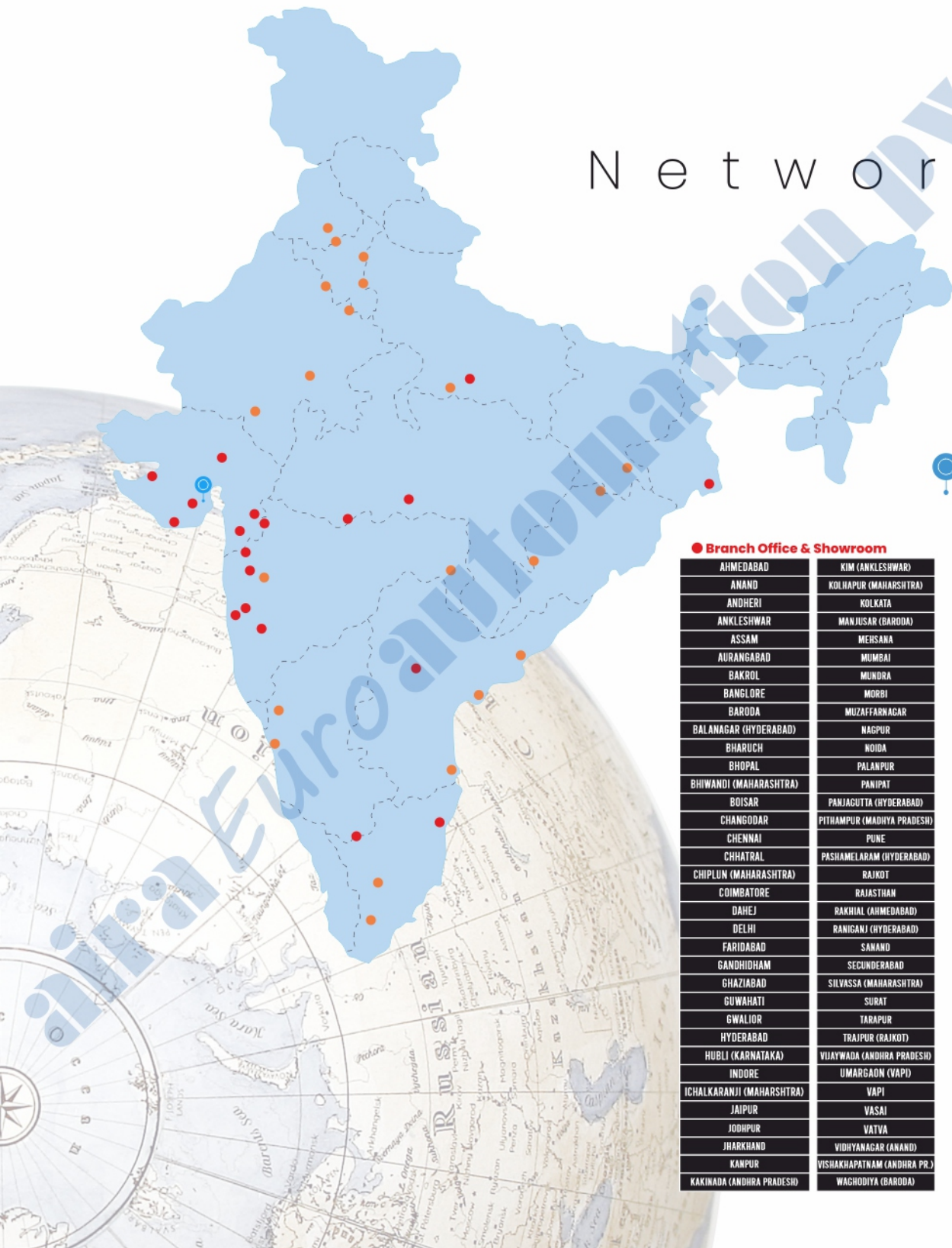

 Head Office & Works
AHMEDABAD

● Branch Office & Showroom

AHMEDABAD	KIM (ANKLESHWAR)
ANAND	KOLHAPUR (MAHARASHTRA)
ANDHERI	KOLKATA
ANKLESHWAR	MANJUSAR (BARODA)
ASSAM	MEHSANA
AURANGABAD	MUMBAI
BAKROL	MUNDRA
BANGLORE	MORBI
BARODA	MUZAFFARNAGAR
BALANAGAR (HYDERABAD)	NAGPUR
BHARUCH	NOIDA
BHOPAL	PALANPUR
BHIWANDI (MAHARASHTRA)	PANIPAT
BOISAR	PANJAGUTA (HYDERABAD)
CHANGODAR	PITHAMPUR (MADHYA PRADESH)
CHENNAI	PUNE
CHHATRAL	PASHAMELARAM (HYDERABAD)
CHIPLUN (MAHARASHTRA)	RAJKOT
COIMBATORE	RAJASTHAN
DAHEJ	RAKHIAL (AHMEDABAD)
DELHI	RANIGANJ (HYDERABAD)
FARIDABAD	SANAND
GANDHIDHAM	SECUNDERABAD
GHAZIABAD	SILVASSA (MAHARASHTRA)
GUWAHATI	SURAT
GWALIOR	TARAPUR
HYDERABAD	TRAJIPUR (RAJKOT)
HUBLI (KARNATAKA)	VIJAYWADA (ANDHRA PRADESH)
INDORE	UMARGAON (VAPI)
ICHALKARANJI (MAHARASHTRA)	VAPI
JAIPUR	VASAI
JODHPUR	VATVA
JHARKHAND	VIDHYANAGAR (ANAND)
KANPUR	VISHAKHAPATNAM (ANDHRA PR.)
KAKINADA (ANDHRA PRADESH)	WAGHODIYA (BARODA)

● Dealers & Distributors

AMRITSAR	KOLKATA
BALOTA	LUCKNOW
BANGLORE	LUDHIANA
BELGAUM	MARWAR
BHILWARA	MEERUT
CHANDICARH	MUZAFFARNAGAR
CHENNAI	NAGPUR
COCHIN	NOIDA
COIMBATORE	PANIPAT
DELHI	PEENYA
ERODE	PUNE
FARIDABAD	TRIPUR
GHAZIABAD	VARANASI
GOA	VISAKHAPATNAM
INDORE	WADI
JALANDHAR	KANPUR
JAMSHEDPUR	KOLHAPUR
JHARKHAND	



aira Euroautomation

Mfg. & Mkt by :

aira Euroautomation pvt. ltd.

INDIA

Available At :

Empty box for distributor information



www.airaindia.com