

Your Solution Partner In
Industrial Valve Automation...



SINGLE & DOUBLE ACTING ALUMINIUM 180° ROTATION PNEUMATIC ACTUATOR



Features

- Single Acting and double acting 180° rotation rack and pinion actuators. [SIL3, ATEX, CE APPROVED] Validated for 5,00,000 cycles
- Hard anodised Aluminium body and stainless steel version also available.
- ISO 5211 mounting pad in all rotary actuators for easy mounting
- Wide variety of torque range
- Single Acting scotch and yoke actuators manufactured for torques upto 1,10,000NM.
- Complete automation accessories manufactured by us such as limit switches, positioner, FR, etc.



Mfg. & Mkt by
aira Euroautomation pvt. Ltd.

INDIA

www.airaindia.com



About Us

Clients are why we exist!

We welcome and thank you for referring out detailed catalogue.

aira is know all over continents as a manufacturer of quality products - Ball Valves, Butterfly Valves, Plug Valves, & Control On / Off Valves with Pneumatic Actuators for Pharma, Oil & Gas, Steel, Paper, Water, Chemical and all type of processing industries.

aira has walked through more than 3 decades, gaining valuable experience, offering equipment's in the products manufactured by OEMs in all spheres of engineering. **aira** products have gained reputations of consultants, and approvals of users, OEMs and other as a quality product.

aira has expanding business into foreign markets specially GCC, UAE, Asian & African countries. This is because increase its customer base and revenue, leading to overall growth and success. Now foreign users come to know and believe in the services provided by the **aira**. Along with the same, it also helps to reach a large number of users thereby leading to the increase their business.

Being and ISO 9001 BVQI certified company has put **aira** in fore front. Out motto is "Value the customer" and "Superior product", one among the best in the world.

Our Quality

- In- House full scale testing facility.
- Lean manufacturing practices
- Certified by : ISO 9001 : 2015 (BVQI LONDON), CE, ATEX, CIMFR, BIS, PESO, SIL 3, IBR
- API 609, API 6D

Our Commitment

- To understand customer's need first before proposing our products.
- To keep on providing competitive rate's by adapting to continuous process improvement, without compromising on quality.
- To provide continuous support to our customers and go beyond their expectations in terms of delivery and after sale services.

Our Manufacturing Facility

- In house R & D, manufacturing and testing facility is all located in a spread over three campuses at Ahmedabad, Gujarat, INDIA.

Network - Sales Office

- 60 Plus Branch Offices in different states in India.
- Sales office in the Bangladesh, Dubai, Kenya, Malaysia, Nepal, Qatar, Singapore, South Africa, Sri Lanka, Turkey, USA (Expanding).



Note : Since, constant worldwide advancement in technology, We keep our rights reserved to make changes time to time in Technical specifications and Dimensions without prior notice.

QMS (Quality Management System)

ISO 9001 : 2015

EMS (Environment Management System)

ISO 14001 : 2015

OHSAS (Occupational Health & Safety Management System)

ISO 45001 : 2018

IBR
PISTON VALVE
GLOBE CONTROL VALVE (CKD/CND)
DISC CHECK VALVE (DCV)
PRESSURE REDUCING VALVE (PRV)
POP TYPE SAFETY VALVE
BALL VALVE

Pneumatic Actuator

CE /
ATEX /
EXIDA SIL-3 /
PROOF OF DESIGN

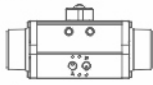

Scotch & Yoke Actuator

CE / ATEX / SIL-3

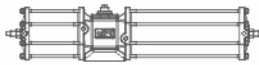

Stainless Steel Actuator

CE /
IEP ATEX



Positioner Enclosure

CE / CIMFR /
IP67 / BIS
/ PESO

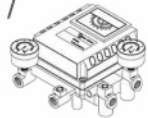

aira's
SOME OF OUR
Certificates

Plug Valve

FUGITIVE EMISSIONS
TEST
AS PER ISO
15848-1 / IBR

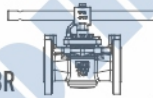

Flameproof Solenoid Valve

IEP ATEX / CE / CIMFR
/ IP65 / IP67 / IP68 /
BIS / PESO

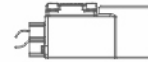

Limit Switch

IEP ATEX / CE / CIMFR
/ IP67 / BIS / PESO /
EQDC IP68

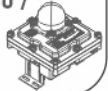

Ball Valve (Floating & Trunnion)

FIRE SAFE TEST DESIGN /
FUGITIVE EMISSIONS TEST
AS PER ISO 15848-1 / CE /
PED / EXIDA SIL-3

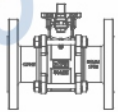

Butterfly Valve (centric / Double & Triple Eccentric)

FIRE SAFE TEST DESIGN /
FUGITIVE EMISSIONS TEST
AS PER ISO 15848-1 / CE /
PED / EXIDA SIL-3
/ IBR / PROOF OF DESIGN /
FOOD GRADE / BIS / ISI



Multiport Ball Valve

FUGITIVE EMISSIONS TEST
AS PER ISO 15848-1 / CE /
PED / EIL

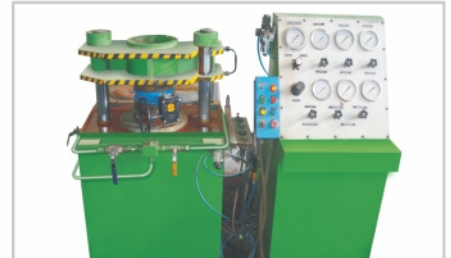
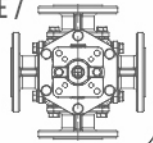

Warranty Information



**Best In Class
4 - Year Warranty**

Aira 'ARA' Actuator manufactured by Aira Euro Automation Pvt. Ltd. are warranted against defects in material or workmanship for a period of four years from date of shipment. Our sole obligation under this warranty is to repair or replace, at our option, any product Aira 'ARA' Actuator products manufactured by Aira Euro Automation Pvt. Ltd. are warranted against defects in material or workmanship for a period of four year from date of shipment. Our sole obligation under this warranty is to repair or replace, at our option, any product or any part or parts thereof found to be defective. Aira Euro Automation Pvt. Ltd. MAKES NO OTHER REPRESENTATION OR WARRANTY, EXPRESS OR IMPLIED, INCLUDING, BUT NOT LIMITED TO, ANY IMPLIED WARRANTY OF MERCHANTABILITY OR FITNESS FOR A PARTICULAR PURPOSE. The warranty set forth above is the only warranty applicable to Aira Euro Automation Pvt. Ltd. products and in no event shall Aira Euro Automation Pvt. Ltd. be liable for any delay, work stoppage, cartage, shipping, loss of use of equipment, loss of time, inconvenience, loss of profits of any direct or indirect incidental resulting from or attributable to a breach of warranty. The remedies under this warranty shall be the only remedies available. OUR MAXIMUM LIABILITY SHALL NOT IN ANY EVENT EXCEED THE CONTRACT PRICE FOR THE PRODUCT.



Note : Since, constant worldwide advancement in technology, We keep our rights reserved to make changes time to time in Technical specifications and Dimensions without prior notice.

POD Certificates validates our vision of making actuators that are at par with most critical needs of our customer

we machine these actuators on world class machinery keeping stringent quality parameters to deliver actuators that Perform

aira® AIRA EURO AUTOMATION PRIVATE LIMITED						
TEST REPORT FOR ACTUATOR AS PER BS EN 15714:2009						
W.O.NO.	PROTOTYPE	W.O.DATE : 24/02/2014				
CUSTOMER	SELF	DRAWING NO. : ARA-90-5A REV : 0				
ACTUATOR SIZE	ARA-90	ACTUATOR TYPE S/A				
ACTUATOR SR.NO.	900114029	20-03-2014				
SR.	TEST	TEST DESCRIPTION	REQUIRED VALUE	OBSERVED VALUE	RESULT	REMARKS
1	TYPE	Output Torque	Nominal Pressure 5.5 Bar/Temp.10 C to 25 C	120 NM	OK	
2	TYPE	Pressure	Shell Test at Bar 8	8 BAR	OK	
3	TYPE	Endurance	5,00,000 cycle [Cycle Time 1=4 second.]	CYCLE 5,00,000	OK	
4	TYPE	Minimum Moving Pressure	Min.Moving Pressure Bar 2 at Temp.10 C to 25 C	OK	OK	
5	ROUTINE	Leakage	shoud complies to en 15714	NO VISIBLE LEAKAGE	OK	
6	TYPE	Operating Time	Max 3 second	OK	OK	
7	TYPE	Angel	90 [Range - 0 to 5]	90°	OK	
8	TYPE	Air Consumption	Std.Value	OK	OK	
9	TYPE	Enclosure	shoud complies to EN 60529	OK	OK	
10	TYPE	Corrosion protection	shoud complies to ISO 9277 REP. NO	ENV/G.0890/0900	OK	
10	TYPE	Basic Design	AIRA Design	OK	OK	
11	TYPE	position Indicator	ON-OFF Positioner.	OK	OK	
Above material has been inspected and complies to BS EN 15714:2009						
Tested By :				Approved By :		

POD Certificates available for complete range of Double & Single Acting Rack & Pinion Actuators Validating **5,00,000 CYCLES**

aira® AIRA EURO AUTOMATION PRIVATE LIMITED						
TEST REPORT FOR ACTUATOR AS PER BS EN 15714:2009						
W.O.NO.	PROTOTYPE	W.O.DATE : 22/12/2013				
CUSTOMER	SELF	DRAWING NO. : ARA-90-5D REV : 0				
ACTUATOR SIZE	ARA-90	ACTUATOR TYPE D/A				
ACTUATOR SR.NO.	90113085	18/11/2013				
SR.	TEST	TEST DESCRIPTION	REQUIRED VALUE	OBSERVED VALUE	RESULT	REMARKS
1	TYPE	Output Torque	Nominal Pressure 5.5 Bar/Temp.10 C to 25 C	142 NM	OK	
2	TYPE	Pressure	Shell Test at Bar 8	8 BAR	OK	
3	TYPE	Endurance	5,00,000 cycle [Cycle Time 1=4 second.]	CYCLE 5,00,000	OK	
4	TYPE	Minimum Moving Pressure	Min.Moving Pressure Bar 2 at Temp.10 C to 25 C	OK	OK	
5	ROUTINE	Leakage	shoud complies to en 15714	NO VISIBLE LEAKAGE	OK	
6	TYPE	Operating Time	Max 3 second	OK	OK	
7	TYPE	Angel	90 [Range - 0 to 5]	90°	OK	
8	TYPE	Air Consumption	Std.Value	OK	OK	
9	TYPE	Enclosure	shoud complies to EN 60529	OK	OK	
10	TYPE	Corrosion protection	shoud complies to ISO 9277 REP. NO	ENV/G.0890/0900	OK	
10	TYPE	Basic Design	AIRA Design	OK	OK	
11	TYPE	position Indicator	ON-OFF Positioner.	OK	OK	
Above material has been inspected and complies to BS EN 15714:2009						
Tested By :				Approved By :		



Note : Since, constant worldwide advancement in technology, We keep our rights reserved to make changes time to time in Technical specifications and Dimensions without prior notice.

Pneumatic Rotary Rack & Pinion Actuator [Double & Single Acting] 180° ROTATION



"aira" Offers ISO 5211 Standard Pneumatic Actuator for all your 180° Valves & Dampers Automation Requirements

Features :

- Suitable typically for 3 way valves, requiring ON-OFF operation. It is available in both single acting (spring return) or double acting versions
- The single acting 180° actuator can provide center off for the 3 way ball valve, bottom entry by choosing the option, of 3 position
- The end stop adjustment is provided for opening and closing direction as a standard
- Actuator mounting is as per ISO 5211 & Accessories to Namur Solenoid Valve

General Features

- Operating Pressure : 3 to 8 Bar
- Temperature Range : -20 °C to 90 °C
- Air Supply : Filtered, dry or lubricated
- Ext. Protection : Corrosion resistant to 500 hours in slatted fog

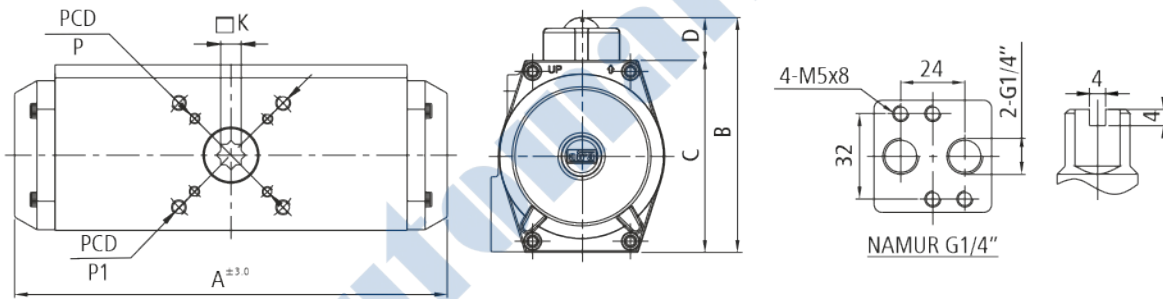

Double Acting Dimensions :

Valve Model	A	B	C	D	PCD P	PCD P1	SQUARE □K	WEIGHT (Approx) Kgs.	Air Consumption In Liters / Bar
ARA - 328	170	82	54.2	28.25	36	50	9 X 9	On Request	On Request
ARA - 508	218	102	74	28.45	50	70	14 X 14		
ARA - 758	293	126.5	100	28.3	50	70	17 X 17		
ARA - 908	402	145.5	117	28.26	—	70	17 X 17		
ARA - 1108	398	166	140	28.30	70	102	22 X 22		

(All Dimensions are in mm)

Single Acting Dimensions :

Valve Model	A	B	C	D	PCD P	PCD P1	SQUARE □K	WEIGHT (Approx) Kgs.	Air Consumption In Liters / Bar
ARA - 1108 - S	550	166	140	28.30	70	102	22 X 22	On Request	On Request

(All Dimensions are in mm)



Note : Since, constant worldwide advancement in technology, We keep our rights reserved to make changes time to time in Technical specifications and Dimensions without prior notice.

No.	Description	Material
1	Body	Aluminium Alloy
2	Piston	Aluminium Alloy
3	Shaft	EN 8
4	End Cover	Aluminium Alloy
5	Shaft Washer	S. S.
6	Indicator	Nylon
7	L. N. Bolt for End Cap	S. S.
8	All Seals	Hi - Nitrile
9	All Guides	Delrin

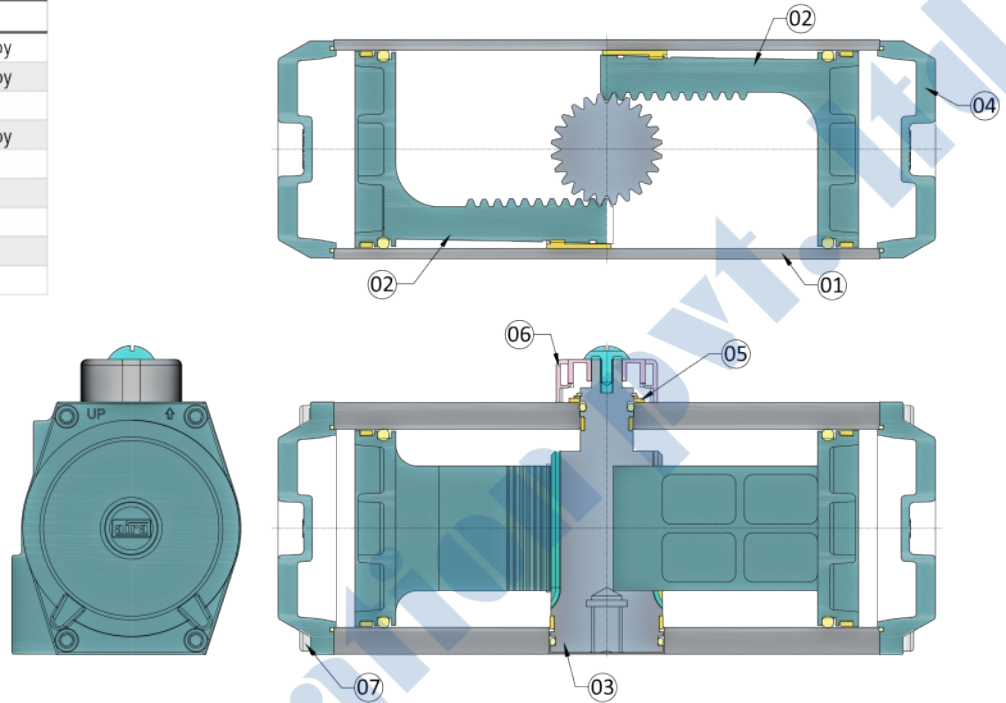

"aira" ACTUATOR SELECTION

Selection of Double Acting Actuator

- Conclude your required torque valve.
- Increase 15% for an acceptable safety factor. (Safety factor depends on media passing through valve.)
- Now look on torque chart and find near by higher torque value of your required torque.
- The found position shows the model of "aira" actuator & operating pressure in bar we need

Example

- Suppose we need 55 Nm torque to drive a valve.
- Increase 15%-63.3 Nm for safety factor.
- In below table the nearby higher torque value is 78 at operating pressure 6 bar.
- This indicators to selection the "aira" actuators model ARA-DD-75-D

DOUBLE ACTING ACTUATOR TORQUE CHART IN Nm						(10Nm = 1 kgfm)
Valve Model	3 BAR	4 BAR	5 BAR	6 BAR	7 BAR	
ARA - 328	3.1	4.1	5.7	6.0	10.3	
ARA - 508	14.7	19.5	22	25	34.6	
ARA - 758	36.60	52.4	65.1	70	92	
ARA - 908	65.90	96	121.5	135	170.5	
ARA - 1108	114	140	177	200	253	

Note : Actuator Torques May Vary $\pm 3\%$.

Note : Single Acting Actuator Torque Available On Request

Model : APP-1200-L
APP-1200-R

"aira" Rotary / Liner Type Pneumatic - Pneumatic Valve Positioner



Input Signal : 3 ~ 15psi (0.2-1.0 kgf/cm²)
Supply Air Pressure : 100 psi Max. (7.0 kgf/cm²)
Standard Stroke : 10 ~ 80mm
Air Piping Connection : 1/4" NPT (F)
Temperature : -20 °C to 70 °C
Pressure Gauge : Stainless Steel
Explosion-Proof : Ex 'd' II CT6
Degree of Protection : IP66
Pressure Gauge : Stainless Steel 0-2 kg/cm²
0-4 kg/cm² / 0-10 kg/cm²
Output : Rotary

Characteristics
Linearity : Within ± 1.0% F.S.
Sensitivity : Within 0.2% F.S.
Hysteresis : Within 0.2% F.S.
Repeatability : Within ± 0.75% F.S.
Air Consumption : 5.0 LPM (1.4 kg/cm²) Supply
Flow Capacity : 80 LPM (1.4 kg/cm²) Supply
Material : Aluminium Die cast Body
Weight : 1.8 Kg. (Approx)

IS / IEC 60079-1
CML-3812155
CIMFR
CE
CCEO Nagpur

Model : AEP-1000-L
AEP-1000-R

"aira" Rotary / Liner Flameproof cum Waetherproof Electro Pneumatic Valve Positioner



Input Signal : 4~20 mA DC
Input Resistance : 235 ±15
Supply Air Pressure : 20 ~ 100psi (7.0 kg/cm²)
Standard Stroke : 10 ~ 80mm
Air Piping Connection : 1/4" NPT (F)
Conduit Connection : 1/2" NPT (F)
Explosion-proof : Ex 'd' II CT6
Degree of Protection : IP66
Temperature : -20 °C to 70 °C
Pressure Gauge : Stainless Steel 0-2 kg/cm²
0-4 kg/cm² / 0-10 kg/cm²
Output Characteristics : Rotary

Linearity : Within ± 1.0% F.S.
Sensitivity : Within 0.2% F.S.
Hysteresis : Within 0.75% F.S.
Repeatability : Within ± 0.5% F.S.
Air Consumption : 5.0 LPM (1.4 kg/cm²) Supply
Flow Capacity : 80 LPM (1.4 kg/cm²) Supply
Material : Alluminium Die Cast Body
Weight : 2.8 Kg. With a terminal box

IS / IEC 60079-1
CML-3812155
CIMFR
CE
CCEO Nagpur

"aira" Weatherproof Micro Limit Switch Box Dom Indicator Type On/Off Indicator



Type : Mechanical Switch X 2 / Proximity Sensors P&F Make
Model : LA4 - FLP - 01
Switch : Honeywell V15 / Honeywell V15 / NJ2-V3-N (Upto 8V) / NBB3-V3-Z4 (Upto 10 to 60 VDC)
Type : 1 NO + 1 NC / 2 NO + 2 NC
Switch Rating : AC 250V 3A, 125V 5A & DC 250V 0.2A, 125V 0.4A, 30V 4A
Enclosure Protection : IP 67
Temperature : -20 °C ~ 80 °C
Conduit Entry : NPT 1/2" (PT 1/2", PF 1/2", M20, PG 13.5)
Terminal Mounting : 8 Points
Bracket : Namur VDI / VDE 3845, ISO 5211
Material : Aluminum Pressure Die Cast / S.S.

Stainless Steel
CIMFR
CE

"aira" Flameproof Limit Switch Box

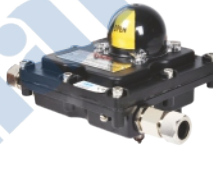

Type : Mechanical Switch X 2 / Proximity Sensors P&F Make
Model : MLS - BX - FLP - 01
Switch : Honeywell V15 / Honeywell V15 PCB Type / NJ2-V3-N (Upto 8V) / NBB3-V3-Z4 (Upto 10 to 60 VDC)
Type : 1 NO + 1 NC / 2 NO + 2 NC
Switch Rating : AC 250V 3A, 125V 5A & DC 250V 0.2A, 125V 0.4A, 30V 4A
Enclosure Protection : IP 67 / IP 68
Temperature : -20 °C ~ 80 °C
Conduit Entry : NPT 1/2" (PT 1/2", PF 1/2", M20, PG 13.5)
Terminal Mounting : 8 Points
Bracket : Namur VDI / VDE 3845, ISO 5211
Material : Aluminum Pressure Die Cast

IS / IEC 60079-1
CML-3812155
CIMFR
CE
CCEO Nagpur

"aira" Flameproof Micro Limit Switch Box with Stainless Steel 304 / 316



Type : Mechanical Switch X 2 / Proximity Sensors P&F Make
Model : LS4 - FLP-01
Switch : Honeywell V15 / Honeywell V15 PCB Type / NJ2-V3-N (Upto 8V) / NBB3-V3-Z4 (Upto 10 to 60 VDC)
Type : 1 NO + 1 NC / 2 NO + 2 NC
Switch Rating : AC 250V 3A, 125V 5A & DC 250V 0.2A, 125V 0.4A, 30V 4A
Enclosure Protection : IP 67
Temperature : -20 °C ~ 80 °C
Conduit Entry : NPT 1/2" (PT 1/2", PF 1/2", M20, PG 13.5)
Terminal Mounting : 8 Points
Bracket : Namur VDI / VDE 3845, ISO 5211
Material : Stainless Steel 304 / 316

CIMFR
CE

"aira" Weatherproof Limit Switch Box



Type : Mechanical Switch X 2 / Proximity Sensors P&F Make
Model : MMLS - BX - WP - 01
Switch : Honeywell ZM / NJ2 - V3 - N (Upto 8 Voltage) / NBB - V3 - Z4 (Upto 10 to 60 VDC)
Type : 1 NO + 1 NC
Switch Rating : AC 250V 3A, 125V 5A & DC 250V 0.2A, 125V 0.4A, 30V 4A
Enclosure Protection : IP 67
Temperature : -20 °C ~ 80 °C
Conduit Entry : NPT 1/2" (PT 1/2", PF 1/2", M20, PG 13.5)
Terminal Mounting : 8 Points
Bracket : Namur VDI / VDE 3845, ISO 5211
Material : Aluminum Pressure Die Cast

CIMFR
CE

	<p>"aira" 3/2 Way Namur Direct Acting Solenoid Valve</p> <p>Model : NAM-SA-32 Coil Voltage : All Std. Voltage Available Frequency : 50 - 60 Hz Connection Type : 1/4" (BSP / NPT) Conduit : PF 1/2" Coil Insulation Grade : Class "F" Temperature : -20 °C ~ 70 °C (-4 ~ 158 °F) MOC : Aluminium Seals : NBR (Viton On Request) Working Pressure : Upto 8 BAR</p> <p>This 3/2 Namur is suitable for actuator model : 5412-S / ARA-49S / ARA-50S</p>		<p>"aira" 3/2 & 5/2 Way Convertible Poppet Type Single Namur Solenoid Valve</p> <p>Model : OTX - PPT - 32 / OTX - PPT - 52 Coil Voltage : All Std. Voltage Available Frequency : 50 - 60 Hz Connection Type : 1/4" (BSP / NPT) Conduit : PF 1/2" Coil Insulation Grade : Class "F" Temperature : -20 °C ~ 70 °C (-4 ~ 158 °F) MOC : Aluminium Seals : NBR (Viton On Request) Working Pressure : Upto 8 BAR</p>
	<p>"aira" 3/2 & 5/2 Way Convertible Poppet Type Double Namur Solenoid Valve</p> <p>Model : 2OTX - PPT - 52 Coil Voltage : All Std. Voltage Available Frequency : 50 - 60 Hz Connection Type : 1/4" (BSP / NPT) Conduit : PF 1/2" Coil Insulation Grade : Class "F" Temperature : -20 °C ~ 70 °C (-4 ~ 158 °F) MOC : Aluminium Seals : NBR (Viton On Request) Working Pressure : Upto 8 BAR</p>		<p>"aira" 3/2 & 5/2 Way Convertible Spool Type Single Namur Solenoid Valve</p> <p>Model : AMV-NAM-220 Coil Voltage : All Std. Voltage Available Frequency : 50 - 60 Hz Connection Type : 1/4" (BSP / NPT) Conduit : PF 1/2" Coil Insulation Grade : Class "F" Temperature : -20 °C ~ 70 °C (-4 ~ 158 °F) Body Material : Aluminium Seals : NBR (Viton On Request) Working Pressure : Upto 8 BAR</p>
	<p>"aira" 3/2 & 5/2 Way Convertible Spool Type Double Namur Solenoid Valve</p> <p>Model : 2AMV-NAM-220 Coil Voltage : All Std. Voltage Available Frequency : 50 - 60 Hz Connection Type : 1/4" (BSP / NPT) Conduit : PF 1/2" Coil Insulation Grade : Class "F" Temperature : -20 °C ~ 70 °C (-4 ~ 158 °F) Body Material : Aluminium Seals : NBR (Viton On Request) Working Pressure : Upto 8 BAR</p>		<p>AJ & CJ Series 3/2 Way Direct Acting Solenoid Valve (Normally Open & Closed)</p> <p>Model : AJDS / AJCS / CJDS / CJCS Size : 1/4" BSP Body : Aluminium Pressure Die Cast Orifice : 2 MM Pressure : 7 Kg/cm² / 10 Kg/cm² Temp. : Upto 50 °C Leakage : Bubble Tight Frequency : 50 ~ 60 Hz Coil Insulation Grade : Class "F" Media : Air (Filtered & Lubricated) Voltage : All Std. Voltage Available</p>
	<p>"aira" Filter + Regulator Air Combination</p> <p>Model : 4FQ / 8 FQ / FRJ Air Connection : 1/4" BSP Max. Supply Pressure : 4FQ : 0.5 to 4 Kg/cm² 8FQ : 0.5 to 8 Kg/cm² 1 to 9 Kg/cm² Gauge Connection : 1/8" Ambient Temperature : -20 °C ~ 120 °C (High Temp.) -40 °C ~ 120 °C (Low Temp.) Mini Filtering Size : 5 Micron Material : Aluminium Pressure Die Cast</p>		<p>"aira" Air Volume Booster</p> <p>Model : VLB Size : 1/4" to 1" BSP MOC : Aluminium / S. S. 304 / 316 Seals : NBR Max. Supply Pressure : Max. 1Mpa (10 Bar) Max. Output Pressure : Max. 0.7 Mpa (7 Bar) Temperature : -20 °C ~ 70 °C (Standard) -20 °C ~ 120 °C (High) -40 °C ~ 70 °C (Low) Linearity : 1 : 1 Hysteresis : 1%</p>
	<p>"aira" Single & Double Air Lock Valve</p> <p>Model : SALV / DALV Material : Aluminum / Stainless Steel 304 Max. Supply Pressure : Max. 10.2 Kg/cm² (142 PSI) Max. Single Pressure : Max. 7.1 Kg/cm² (1000 PSI) Setting Pressure Range : 1.4-7.1 Kg/cm² (20 ~ 100 PSI) Flow Capacity (Cv) : 0.9 In/Output Port Connection : 1/4" NPT Signal Port Connection : 1/4" NPT Differential Pressure : Below 0.1 Kg/cm² (1.4 PSI) Hysteresis : 1% ambient Temp. : -20 °C ~ 70 °C</p>		<p>"aira" Manual Override Clutch Type (MO)</p> <p>Model : AMO Torque : 200 Nm to 10000 Nm Body : Aluminium Pressure Die Cast / S. G. Iron Lever Wheel : Stainless Steel Hand Wheel : S. S. / M. S. (Fabricated)</p>



time tested designs with superior performance

GLOBAL

Network

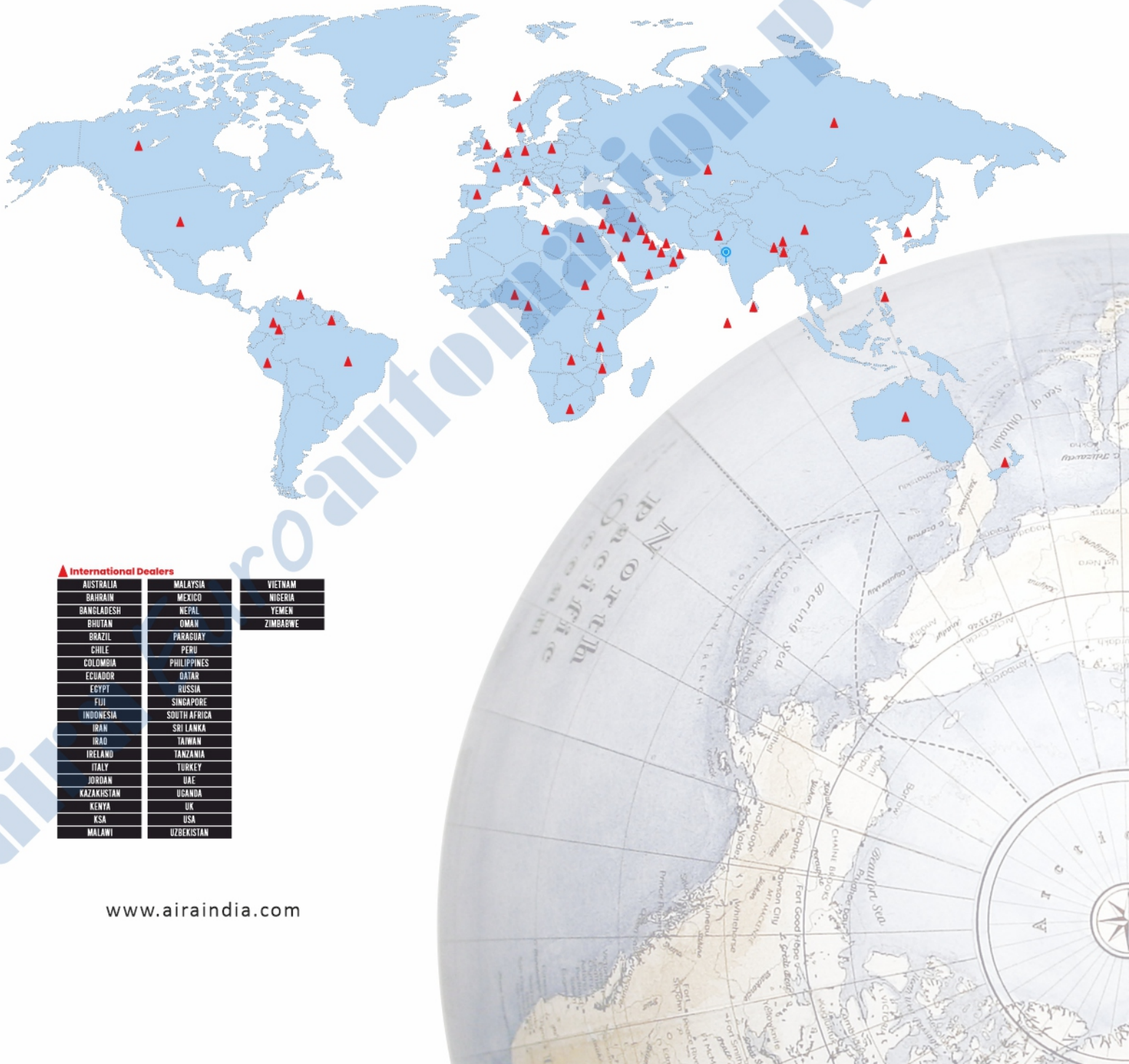

▲ International Dealers

AUSTRALIA	MALAYSIA	VIETNAM
BAHRAIN	MEXICO	NIGERIA
BANGLADESH	NEPAL	YEMEN
BHUTAN	OMAN	ZIMBABWE
BRAZIL	PARAGUAY	
CHILE	PERU	
COLOMBIA	PHILIPPINES	
ECUADOR	QATAR	
EGYPT	RUSSIA	
FUJI	SINGAPORE	
INDONESIA	SOUTH AFRICA	
IRAN	SRI LANKA	
IRAQ	TAIWAN	
IRELAND	TANZANIA	
ITALY	TURKEY	
JORDAN	UAE	
KAZAKHISTAN	UGANDA	
KENYA	UK	
KSA	USA	
MALAWI	UZBEKISTAN	



industrial valve automation

Network

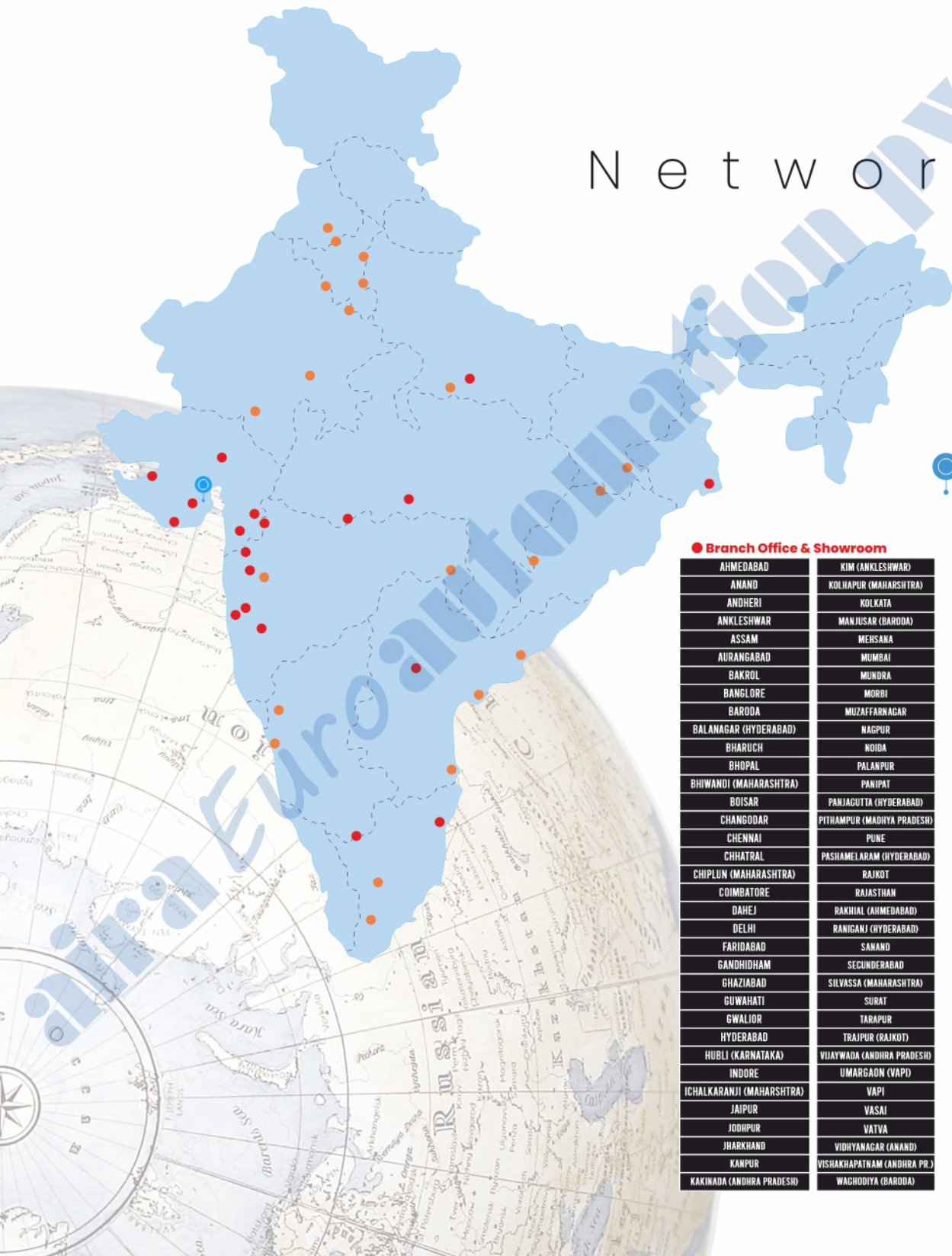

 Head Office & Works
AHMEDABAD

● Branch Office & Showroom

AHMEDABAD	KIM (ANKLESHWAR)
ANAND	KOLHAPUR (MAHARASHTRA)
ANDHERI	KOLKATA
ANKLESHWAR	MANJUSAR (BARODA)
ASSAM	MEHSANA
AURANGABAD	MUMBAI
BAKROL	MUNDRA
BANGLORE	MORBI
BARODA	MUZAFFARNAGAR
BALANAGAR (HYDERABAD)	NAGPUR
BHARUCH	NOIDA
BHOPAL	PALANPUR
BHIWANDI (MAHARASHTRA)	PANIPAT
BOISAR	PANJAGUTA (HYDERABAD)
CHANGODAR	PITHAMPUR (MADHYA PRADESH)
CHENNAI	PUNE
CHHATRAL	PASHAMELARAM (HYDERABAD)
CHIPLUN (MAHARASHTRA)	RAJKOT
COIMBATORE	RAJASTHAN
DAHEJ	RAKHIAL (AHMEDABAD)
DELHI	RANIGANJ (HYDERABAD)
FARIDABAD	SANAND
GANDHIDHAM	SECUNDERABAD
GHAZIABAD	SILVASSA (MAHARASHTRA)
GUWAHATI	SURAT
GWALIOR	TARAPUR
HYDERABAD	TRAJIPUR (RAJKOT)
HUBLI (KARNATAKA)	VIJAYWADA (ANDHRA PRADESH)
INDORE	UMARGAON (VAPI)
ICHALKARANJI (MAHARASHTRA)	VAPI
JAIPUR	VASAI
JODHPUR	VATVA
JHARKHAND	VIDHYANAGAR (ANAND)
KANPUR	VISHAKHAPATNAM (ANDHRA PR.)
KAKINADA (ANDHRA PRADESH)	WAGHODIYA (BARODA)

● Dealers & Distributors

AMRITSAR	KOLKATA
BALOTA	LUCKNOW
BANGLORE	LUDHIANA
BELGAUM	MARWAR
BHILWARA	MEERUT
CHANDICARH	MUZAFFARNAGAR
CHENNAI	NAGPUR
COCHIN	NOIDA
COIMBATORE	PANIPAT
DELHI	PEENYA
ERODE	PUNE
FARIDABAD	TRIPUR
GHAZIABAD	VARANASI
GOA	VISAKHAPATNAM
INDORE	WADI
JALANDHAR	KANPUR
JAMSHEDPUR	KOLHAPUR
JHARKHAND	



Available At :

Mfg. & Mkt by
aira Euroautomation pvt. Ltd.
INDIA